

# Gas Sample Probe Series SP<sup>®</sup>

## SP3200V /.../HEX5-x.08, SP3200 /.../RS/HEX5-x.08

 II 3 GD

Instruction Manual  
Version 1.00.06



**Dear customer,**

Thank you for buying our product. In this manual you will find all necessary information about this M&C product. The information in the manual is fast and easy to find, so you can start using your M&C product right after you have read the manual.

If you have any question regarding the product or the application, please don't hesitate to contact M&C or your M&C authorized distributor. You will find all the addresses in the appendix of this instruction manual.

For additional information about our products, please go to M&C's website [www.mc-techgroup.com](http://www.mc-techgroup.com). There you can find the data sheets and manuals of our products in German and English.

This instruction manual does not claim completeness and may be subject to technical modifications.

© 03/2023 **M&C Techgroup** Germany GmbH. Reproduction of this document or its content is not allowed without permission from **M&C**.

**SP**® is a registered trade mark.

With the release of this version all older manual versions will no longer be valid. The German instruction manual is the original instruction manual. In case of arbitration only the German wording shall be valid and binding.

Version: 1.00.06

## Contents

<b>1</b>	<b>General information</b> .....	<b>5</b>
<b>2</b>	<b>Declaration of conformity</b> .....	<b>5</b>
<b>3</b>	<b>Safety information</b> .....	<b>6</b>
<b>4</b>	<b>Information for use in hazardous areas</b> .....	<b>7</b>
<b>5</b>	<b>Warranty</b> .....	<b>7</b>
<b>6</b>	<b>Terms and signals used in this manual</b> .....	<b>8</b>
<b>7</b>	<b>Application</b> .....	<b>10</b>
<b>8</b>	<b>Description</b> .....	<b>10</b>
8.1	SP3200V and SP3200 (combustible gases and dust):.....	10
<b>9</b>	<b>Options</b> .....	<b>13</b>
9.1	Backflush unit type /RS .....	14
9.2	Option /R, /BB and /BBF for test gas feeding or backflushing via check valve R 1/4", BB 3/8" or BBF 3/8" .....	14
9.3	Option /C/I test gas feeding via check valve behind the probe filter with pneumatic stop valve of the probe outlet to the process .....	15
9.4	Option 2-Way ball valve .....	15
9.5	Option spun glass cartridge FW .....	15
9.6	Option /3VA test gas feeding and backflushing VIA 3/2-Way ball valve .....	16
9.7	Ball valve drive MS1 .....	17
9.8	Option /2X second sample gas outlet on the probe .....	17
9.9	Option /PT100: Additional PT100 with terminal box for external temperature control .....	17
9.10	Probe heating.....	17
<b>10</b>	<b>Technical Data</b> .....	<b>18</b>
10.1	Maximum surface temperature of the gas sample probe:.....	21
<b>11</b>	<b>Receipt of goods and storage</b> .....	<b>22</b>
<b>12</b>	<b>Preparations for installation</b> .....	<b>23</b>
<b>13</b>	<b>Installation</b> .....	<b>24</b>
13.1	Connection of the sample line.....	27
<b>14</b>	<b>Electrical connection</b> .....	<b>29</b>
<b>15</b>	<b>Starting-up</b> .....	<b>30</b>
<b>16</b>	<b>Maintenance</b> .....	<b>30</b>
16.1	Replacement of the filter element.....	31
16.2	Replacement of the preliminary filter .....	32
16.3	Cleaning of the probe .....	32
<b>17</b>	<b>Shutdown</b> .....	<b>32</b>
<b>18</b>	<b>Proper disposal of the device</b> .....	<b>32</b>
<b>19</b>	<b>Spare parts list</b> .....	<b>33</b>
<b>20</b>	<b>Annex</b> .....	<b>33</b>

## Figures

Figure 1	Probe SP3200(V) without options with preliminary filter V20 .....	11
Figure 2	Schematic view of the options for backflush and test gas feeding .....	13
Figure 3	Function scheme of the option 3/2-way ball valve /3VA.....	16
Figure 4	Schematic drawing of the filter housing cover .....	25
Figure 5	Removal of the filter housing cover.....	26
Figure 6	SP3200 RS, HEX5-1.08 .....	34
Figure 7	SP3200 RS, HEX5-2.08 .....	35

**Tables**

Table 1	Sample tube for use with probe SP3200(V).....	11
Table 2	Possible filters and preliminary filters for use inside the probe.....	12
Table 3	Extension tubes.....	12
Table 4	Maximum surface temperatures for the use of heating HEX5-x.08.....	21
Table 5	Temperature classes for use of heating HEX5-x.08.....	21
Table 6	Operating parameters.....	24



## Head Office

**M&C TechGroup** Germany GmbH ♦ Rehhecke 79 ♦ 40885 Ratingen ♦ Germany

Telephone: 02102 / 935 - 0

Fax: 02102 / 935 - 111

E - mail: [info@mc-techgroup.com](mailto:info@mc-techgroup.com)

[www.mc-techgroup.com](http://www.mc-techgroup.com)

## 1 GENERAL INFORMATION

The product described in this instruction manual has been built and tested in our production facility.

All M&C products are packed to be shipped safely. To ensure the safe operation and to maintain the safe condition, all instructions and regulations stated in this instruction manual need to be followed. This instruction manual includes all information regarding proper transportation, storage, installation, operation and maintenance of this product by qualified personnel.

Follow all instructions and warnings closely.

Read this manual carefully before commissioning and operating the device. If you have any questions regarding the product or the application, please don't hesitate to contact M&C or your M&C authorized distributor.

## 2 DECLARATION OF CONFORMITY



The product described in this operating manual complies with the following EU directives:

### ATEX-Directive

The product described in this manual is produced in accordance with the EU directive for devices and protection systems for appropriate use in hazardous areas 2014/34/EU appendix II. The respective type of protection depends on the variant (see table 4).

### EMV-Instruction

The requirements of the EU directive 2014/30/EU "Electromagnetic compatibility" are met.

### Low Voltage Directive

The requirement of the EU directive 2014/35/EU "Low Voltage Directive" are met.  
The compliance with this EU directive has been examined according to DIN EN 61010.

### RoHS Directive

The requirements of the RoHS2 ('Restriction of Hazardous Substances 2') directive 2011/65/EU and its annexes are met.

### Declaration of conformity

The EU Declaration of conformity can be downloaded from the **M&C** homepage or directly requested from **M&C**.



### 3 SAFETY INFORMATION

Observe the following fundamental safety precautions when using the device:

- Read these operating instructions carefully before start-up and use of the device! The information and warnings given in these operating instructions must be observed.
- Work on electrical equipment may only be carried out by qualified personnel in accordance with up-to-date regulations.
- When erecting high-voltage power installations with rated voltages up to 1000 V, the requirements of VDE 0100 and its associated standards and regulations must be observed.
- For use of the device in hazardous areas, the relevant national and international standards and regulations must be observed.
- The device must be connected to a mains supply with the same voltage as specified on the rating plate.
- Protection against contact with high electrical voltages:  
The device must be safely isolated from the mains supply before it is opened. The same applies to any connected external control circuits.
- Only use the device within the permissible temperature ranges.
- Check that the location of the device is weatherproof. Do not expose it directly to rain or liquids.
- Installation, maintenance, control and eventual repairs may only be carried out by authorized personnel. Such work must be carried out in accordance with applicable rules and regulations.

#### 4 INFORMATION FOR USE IN HAZARDOUS AREAS

Please see the identification of the individual variants in table 4.



Detailed information and a copy of the declaration of conformity are contained in the appendix to these operating instructions. The devices must be installed and used in accordance with the conditions and installation instructions given in the EX-Certificate (see appendix). Only then, a safe operation in hazardous areas is guaranteed.

Any changes to the standard configuration with unspecified parts or parts not authorised by **M&C** as well as repair or service work with unspecified parts leads to an immediate loss of ex-certification.

*- In case of any doubt, please contact directly M&C or your M&C franchise dealer.*

#### 5 WARRANTY

In the event of a device failure, please contact **M&C** directly or your **M&C** franchise dealer.

The device is covered by a one-year warranty starting from the day of delivery according to our normal terms and conditions of sale and assuming a technically correct use of the unit. Wearing parts are not covered by the warranty. The warranty includes free repair at our factory or free replacement of the device which must be sent to us carriage paid and correctly packed.

## 6 TERMS AND SIGNALS USED IN THIS MANUAL



**Danger**

The 'Danger' warning sign indicates that death, serious injury and/or significant material damage will be the consequence, if the appropriate precautions should not be taken.



**Warning**

The 'Warning' warning sign indicates that death, serious injury or damage to property may occur if the relevant precautionary measures are not observed.



**Caution**

The 'Caution' warning sign indicates that slight personal injury can occur if the appropriate safety precautions are not observed.

**Caution**

'Caution' indicates that damage to property can occur if the appropriate safety precautions are not observed.

**Attention**

'Attention' indicates that an unintended result or situation can occur if the corresponding information is not taken into account.



**Note**

'Note' indicates important information relating to the product or highlights parts of the documentation for special attention.

**Qualified personnel**

'Qualified personnel' are experts who are familiar with the installation, commissioning, maintenance, and operation of these types of products. The following knowledge is at least required for the work:

- Instructed person in EX-protection
- Trained person in the electrotechnical field
- Detailed knowledge of the manual and the applicable safety regulations



'Ex' indicates important information about the product or about the corresponding parts in the instruction manual, relating to usage in potentially explosive atmospheres.



High voltages!  
Protect yourself and others against damages which might be caused by high voltages.



Hot surface!  
Contact may cause burn! Do not touch!





Corrosive!

These substances destroy living tissue and equipment upon contact. Do not breathe vapors; avoid contact with skin and eyes.



Wear protective gloves!

Working with chemicals, sharp objects or extremely high temperatures requires wearing protective gloves.



Wear safety glasses!

Protect your eyes while working with chemicals or sharp objects. Wear safety glasses to avoid getting something in your eyes.



Wear protective clothes!

Working with chemicals, sharp objects or extremely high temperatures requires wearing protective clothes.

## 7 APPLICATION

The probes of type **SP3200V..** and **SP3200..** are used for continuous gas sampling in dust-laden processes or processes with high temperatures (according to table 5, chapter 10) or high gas moisture. The modular construction of the probes and the variety of possible options guarantee optimum adaptation of the probes to complex process and environmental conditions.

The probes of the type **SP3200V..** and **SP3200..** are available in both unheated and electrically heated version.

The probes must not be used for sampling of gases or gas mixtures that could be explosive, even in absence of air or which change safety-relevant material properties.



The gases or gas mixtures must also not contain any solid particles that could generate ignitable friction or percussion sparks in combination with the materials of the probe.

It is not allowed that during operation potential sources of ignition (e.g. smouldering or burning particles, glowing embers, foreign objects) are brought into the gas sample probe.

## 8 DESCRIPTION

The probes type **SP3200(V)..** have been designed for easy use, long life and uncomplicated service and maintenance.

The internal filter element can be replaced without the need of tools or dismounting of the sample line. After having removed the internal filter element, both the filter chamber and the sample tube can be cleaned easily.

### 8.1 SP3200V AND SP3200 (COMBUSTIBLE GASES AND DUST):

The gas sample probes type **SP3200V..** and **SP3200..** are suitable for the sampling of gases and installation in hazardous areas of zone 2 or 22 (combustible gases and dust). The only difference between both types is the sealing material of the filter housing. Version **SP3200** has got a filter housing sealing out of graphite for special types which are heated above 185°C. Version **SP3200V** has got filter housing seals of Viton for special types which are heated below or up to 185°C. The probe housing and all options are suitable for use in hazardous areas of zone 2 or 22 (combustible gases and dust). Please read the identification in table 4.

The probe **SP3200(V)..** must not be used for gas sampling in zone 0/1.

The filter system of type **SP3200(V)..** is suitable for dusts of a fineness of up to 2 µm.

After the filtration, i.e. at the outlet of the gas sample probe, the sample gas is free of dust. This means that in the absence of explosive sample gas downstream analysers can be used without any special protective measures. The following figure shows the basic version of the gas sample probe **SP3200(V)** with prefilter.

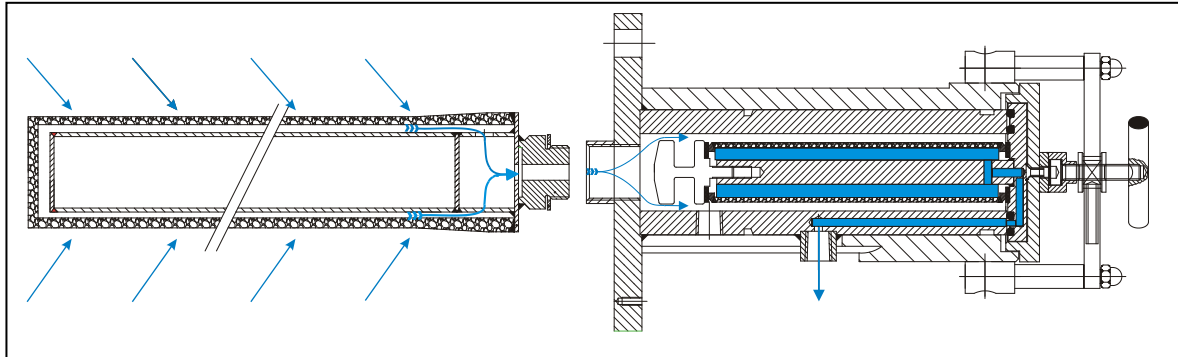

Figure 1 Probe SP3200(V) without options with preliminary filter V20



Warning



#### SP3200V / SP3200:

In case the gas-dust mixture to be examined must be classified as potentially explosive because it contains combustible gases, only downstream devices (flowmeters, analysers) with corresponding identification according to directive **2014/34/EU** must be used. Suitable explosion isolation with a flame arrestor must be established. Any downstream units are not covered by this operating manual.



Warning



For **sampling with probe SP3200(V) from explosion zone 2** sample tubes or pre-filters and extension tubes can be chosen from tables 1 – 3 below.

For **sampling with probe SP3200(V) from explosion zone 22** a pre-filter has to be chosen from table 2 below. Additional extension tubes from table 3 can be chosen.

Sample tube type	Part No.	Max. temperature [°C]	Material Tube/Connection part	Length [mm]	Length „L max“ [mm]	Connection thread „G“	Tube ø o/i [mm]	Connection ø o [mm]
SP2000/SS	<b>20S9065</b>	600	Stainl. steel 1.4571	1000	2500	G 3/4" a	25/22	37
SP2000/SS-Vm	<b>20S9067</b>	600	Stainl. steel 1.4571	1000	2500	G 3/4" a	25/06	37
SP2000/HC	<b>20S9090</b>	900	Hastelloy® x	1000	2500	G 3/4" a	25/22	37
SP2000/KA	<b>20S9080</b>	1300	Kanthal®/1.4571	1000	1500	G 3/4" a	27/20	37
SP2000/IN	<b>20S9077</b>	1100	Inconel	1000	2500	G 3/4" a	25/22	37

Table 1 Sample tube for use with probe SP3200(V)

Type	Part No.	Material	Dimension [mm]	Filter porosity[ $\mu\text{m}$ ]
<b>Filter in the probe:</b>				
S-3 SS150	<b>90F0126</b>	1.4404	150 x 30	2
S-2K150	<b>90S0020</b>	Ceramic Aerolith	150 x 30	2
<b>Option spun glass cartridge FW</b>				
Filter FW (spun glass)	93S2083	Spun glass, high temperature resistant		
<b>Preliminary filters to be selected:</b>				
SP2000ST/V20-T	<b>20S9315</b>	PTFE needled felt (anti-static)	450 x 40	3
SP2000ST/V20-0	<b>20S9105</b>	1.4404	200 x 50	3
SP2000ST/V20-0/HC	<b>20S9115</b>	Hastelloy <sup>®</sup> x	200 x 50	3
SP2000ST/V20-1	<b>20S9145</b>	1.4404	500 x 60	3
SP2000ST/V20-1/HC	<b>20S9155</b>	Hastelloy <sup>®</sup> x	500 x 60	3
SP2000ST/V20-1/HC 0.5 $\mu\text{m}$	<b>20S9156</b>	Hastelloy <sup>®</sup> x	500 x 60	0.5
SP2000ST/V20-3	<b>20S9300</b>	1.4404	1000/300 x 31	3

**Table 2 Possible filters and preliminary filters for use inside the probe**

The preliminary filters can be extended with the following extension tubes.

Extension [mm] with volume displacer	Part No.
500	20S9165
1000	20S9170
1500	20S9175

**Table 3 Extension tubes**

## 9 OPTIONS

The following options are suitable for use in hazardous areas. Please read the identification for the respective zone in table 4.



**Warning**

When selecting options, attention must be paid to the operating parameters.

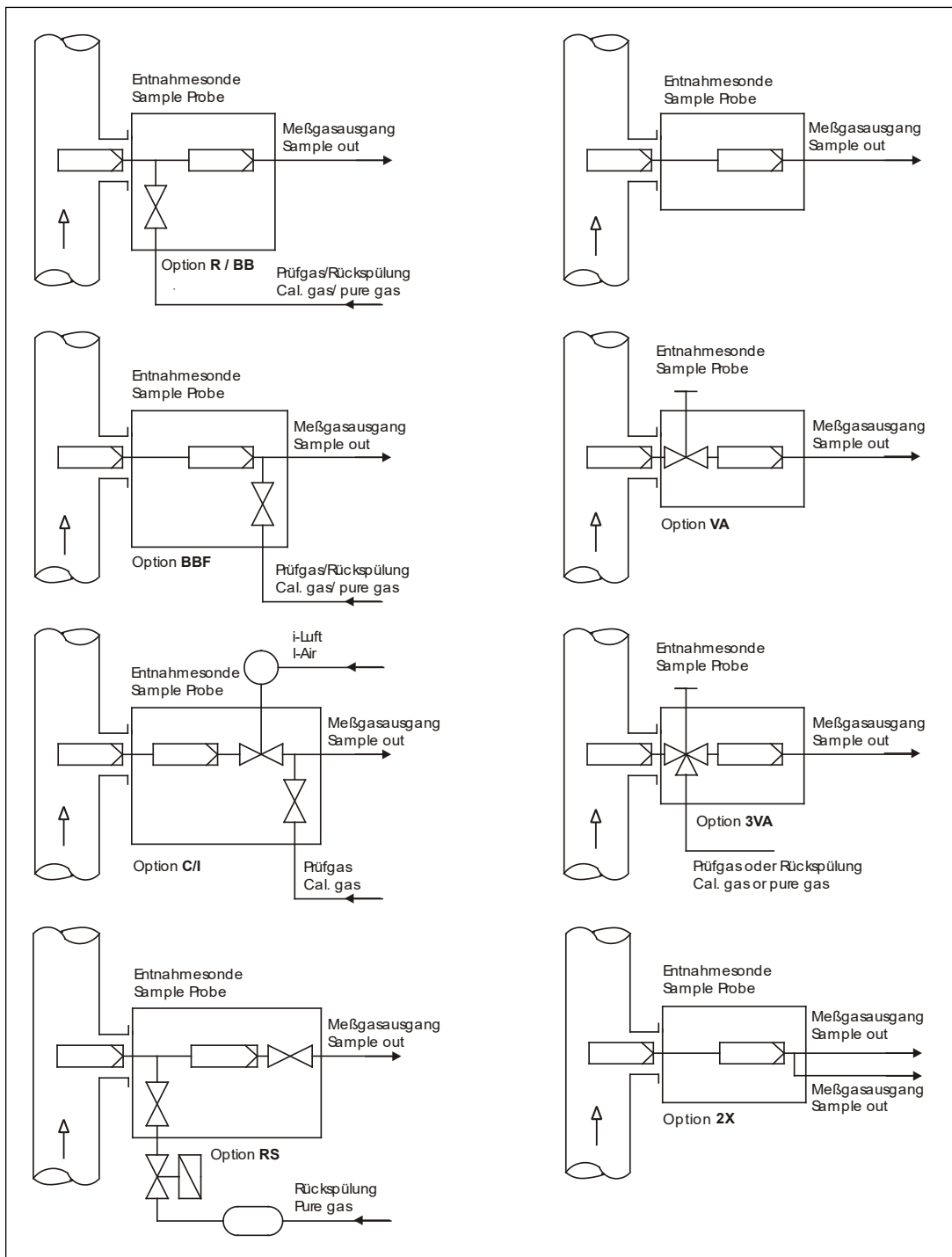

**Figure 2** Schematic view of the options for backflush and test gas feeding

## General safety instructions for back flushing and feeding of calibration gas

A backflushing gas suitable for the sampling point must be selected for backflushing.

The backflushing pressure / calibration gas pressure must always be higher than the process pressure. This minimum pressure must be monitored with a press switch at the inlet side of the accumulator or the check valve. If the flush gas pressure drops below the process pressure, the backflushing solenoid valve must not be operated.



### Warning

The maximum permissible pressures of 6 bar abs. must not be exceeded (see technical data).

Do not choose back flush intervals longer than 3 seconds because in case of strong pollution of the pre-filter pressure inside the probe would be rising and this would lead to a discharging towards the analyzer via the patented pressure control valve in the outlet of the probe due to a defined leak rate of this valve.

At sampling points with inerting, backflushing must be performed with corresponding inert gas. It must be ensured that the inert gas does not introduce oxygen or combustible gases into the system.

## 9.1 BACKFLUSH UNIT TYPE /RS

The backflush unit type **/RS** consists of a pressure relief valve, solenoid valve, accumulator and patented pressure control valve in the probe outlet.

The cyclical operation of the solenoid valve and monitoring of the backflushing pressure must be effected externally. The electrical connection of the solenoid valve must be made in an Ex e connection box. An additional solenoid valve in the sample gas outlet of the probe is not necessary because the patented pressure control valve shuts the probe outlet during back purging in order to protect the downstream analysis against the pressure push of the back purge.

## 9.2 OPTION /R, /BB AND /BBF FOR TEST GAS FEEDING OR BACKFLUSHING VIA CHECK VALVE R 1/4", BB 3/8" OR BBF 3/8"

For back purging of the probe tube or the preliminary filter, flush gas is fed via the check valve. Hereby, it is recommended to separate the downstream analysing system from the probe in order to avoid pressure pushes to the system (Option **/I**). The opening pressure of the check valve is 0,7 bar. The flush gas or calibration gas pressure should be higher than 0,7 bar.

Options **/R** and **/BB** are for backflush of the inside space of the probe and the preliminary filter, the option **BBF** is for backflush of the probe filter and the preliminary filter.



### Note

In order to avoid the cooling down of the inside probe, it is recommended to effect the back-flush in short intervals of < 1 s.

During the feeding of test gas, the analyse system remains connected. The quantity of test gas should be at least 25 % higher than the quantity of sample gas which is taken in by the analysing system, thus avoiding a mixture with the test gas. For processes with overpressure, this kind of feeding the test gas is not recommended. In this case, you should use an integrated ball valve in the inlet of the probe as stop valve.

In principle, you need only a small quantity of test gas for probes with an integrated ball valve, because the probe is separated from the process when the ball valve is activated so that there is no danger of a mixture with the process gas.

In case of manual operation, please turn the turning handle to the right side until the limit stop in order to shut off the probe.

**Note**

In case of low pressure operation, please take into consideration that as from 300 mbar secondary air will be taken in via the non-closed check valve.

### **9.3 OPTION /C/I TEST GAS FEEDING VIA CHECK VALVE BEHIND THE PROBE FILTER WITH PNEUMATIC STOP VALVE OF THE PROBE OUTLET TO THE PROCESS**

By activating the pneumatic stop valve with compressed air, the measuring gas way behind the probe filter is shut off. Now, you can feed test gas via the check valve to the sample gas outlet of the probe without any loss.

### **9.4 OPTION 2-WAY BALL VALVE**

For any service work, eg. changing of the filter element or cleaning works, the stop valve in the probe inlet is actuated from outside with the turning handle. This becomes necessary eg. in case of overpressure in the process or in case of toxic gas components.

**Warning**

In case of toxic gas components, please backflush the probe after shut off and before opening!

### **9.5 OPTION SPUN GLASS CARTRIDGE FW**

With the FW option, the filter element is omitted; instead of the filter element, a spun glass cartridge is mounted on the filter housing lid. This spun glass cartridge is filled with a high temperature resistant spun glass. The option FW is used at sample points with risk of quickly blocking filter surfaces due to tar or sticky substances.

The use of standard filter elements S-3SS150 or S-2K150 is not possible with option FW.

### 9.6 OPTION /3VA TEST GAS FEEDING AND BACKFLUSHING VIA 3/2-WAY BALL VALVE

With the 3/2-way ball valve, you can execute both functions „backflushing“ and „test gas feeding“ one after the other. Only one operation each may be automated via the pneumatic actuation.

This kind of gas feeding provides the advantage that during backflushing the downstream analyse system is automatically separated from the probe respectively, the probe is automatically separated from the process during test gas feeding. For that reason, you need a lower quantity of test gas as no mixture with the process gas may occur.

For the measuring operation, the ball valve must be put into the central position.

For backflushing, the ball valve must be put into the corresponding position. This means in case of manual operation to turn the handle from the central position to the left side as far as it will go.

For the test gas feeding, the ball valve must be turned to the right side as far as it will go.

For the measuring operation, return the ball valve into the neutral position.

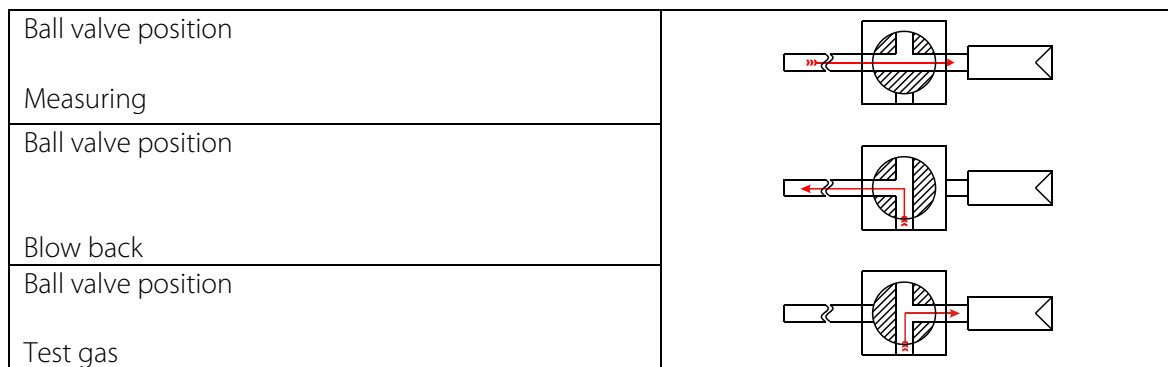

**Figure 3** Function scheme of the option 3/2-way ball valve /3VA



## 9.7 BALL VALVE DRIVE MS1

The following drives are available:

Pneumatic drive with spring return type **MS/ NC** or **NO**  
Hereby 2 operating conditions can be realised:

**a.** Using a shut off ball valve VA the conditions:

"Open=measuring" and "shut".

**b.** Using a 3/2-way ball valve 3VA either the conditions:

"Open=measuring" and "blow back" **or**

"Open=measuring" and "test gas feeding"

Type **MS-C** for test gas feeding and type **MS-B** for blow back.

When placing the order specify, if the ball valve is

**NC**, (shut without control air), or

**NO**, (open without control air). Standard = **NC**

## 9.8 OPTION /2X SECOND SAMPLE GAS OUTLET ON THE PROBE

With this option, the probe has got two sample gas outlets ¼" NPT female.

## 9.9 OPTION /PT100: ADDITIONAL PT100 WITH TERMINAL BOX FOR EXTERNAL TEMPERATURE CONTROL

Additional PT100 (2-wire) with separate terminal box mounted on the probe.

The mounted cable gland fits for cable diameters 7 - 12 mm.

## 9.10 PROBE HEATING

The probe heating type **HEX5-x.08** is suitable for temperature ranges of 85 – 185 °C. It consists of a heating plate with heating cartridges and a control electronic.







For the heater type **HEX5.1.08**, the control electronic is mounted onto the probe. This means a range of the ambient temperature for the probe of 0 – 50 °C.

The probe heating type **HEX5.2.08** is designed for an external mounting of the control unit (in Ex zone 2). For the electrical connection, a terminal box is mounted on the probe which means an ambient temperature range of 0 – 70 °C. The externally mounted control unit can be used within an ambient temperature range of 0 – 50 °C.

Technical data may be taken from the separate operating manual **HEX5-x.08**.

## 10 TECHNICAL DATA

Gas sample probe type	SP3200V (up to 185 °C)	SP3200 (more than 185 °C)
Part No.	20S5705	20S5700
Weather protection shield	Yes	
Filter housing material	Stainless steel 316/316Ti	
Sealing materials	Graphite, FKM	Graphite
Probe flange sealing material	Graphite	
Pre-filter/sample tubes	Optional, see data sheets "Sample Tubes for Gas Sample Probes Series SP®" and "Pre-Filters for Gas Sample Probes Series SP®"	
Sample pressure max.	0.5 to 6 bar abs.	
Ambient temperature	-20 to +60 °C [-4 to 140 °F] depending on option selected	
Permissible process gas temperature	Depending on the temperature class, however max. 200 °C [392 °F] at the probe inlet	
Filter chamber volume	120 cm <sup>3</sup>	
Filter element, porosity	F-3SS150= stainless steel*, 3 µm; S-2K150= ceramic**, 2 µm	
Sample gas outlet connection	1 x 1/4" NPT i for max. 8 mm tube connectors	
Connection gas outlet at option RS	6 mm Swagelok® connector	
Mounting flange	DN 65 PN 6, Form B, SS316Ti* >DN or ANSI possible**	
Weight	7 kg [≈ 15.43 lbs]	

Option heating type HEX5	HEX5-1.08, internal controller	HEX5-2.08, external controller
Part No.	20S9650(a)	20S9655(a)
Mounting of controller	In the Ex-zone 2 and 22	
Control	Electronic	
Power supply	240 V 50/60 Hz or 120 V, 50/60 Hz (a)	
Electrical connection	Cable gland, terminal range 6 – 12 mm, terminals max. 4 mm <sup>2</sup>	
Marking for heater		 II 3G Ex ec IIC T5-T2 Gc (see temp. table),  II 3D Ex tc IIIC T75°C - 235°C Dc CSA Class I, Div. 2, Groups A/B/C/D, T5 - T2B
Marking for controller		 II 3G Ex ec nC IIC T2-T5 Gc (see temp. table),  II 3D Ex tc IIIC T75°C - 235°C Dc CSA Class I, Div. 2, Groups A/B/C/D, T5 - T2B
Marking for heater with internal controller	 II 3G Ex ec nC IIC T5-T2 Gc (see temp. table),  II 3D Ex tc IIIC T75°C - 235°C Dc	

	CSA Class I, Div. 2, Groups A/B/C/D, T5 - T2B	
Admissible medium temperature at the probe inlet	The admissible medium temperature is limited by the materials used (< 200 °C [392 °F]) and by the maximum admissible surface temperatures as shown in table 4.	
Power	Max. 800 W (240 V), max. 830 W (120 V)	
Housing protection	IP65, EN 60529	
Operating temperature	0 to max. 230 °C [32 to max. 446 °F] according to temp. class, pls. indicate with order	
Ambient temperature	0 to +50 °C [32 to 122 °F]	Controller: 0 to +50 °C [32 to 122 °F], heater: -20 to +70 °C [-4 to 158 °F], with back purge unit: -20 to 55 °C [-4 to 131 °F]
Low temperature alarm contact	-5 °C [23 °F] to T <sub>SET</sub> , potential-free closing contact with switching capacity 250 V 3 A AC, 0.25 A DC	
Excess temperature limiter	+5 °C to T <sub>SET</sub> , manual reset	
<b>Option back purge unit type RS</b>	<b>RS</b>	
Part No.	20S5560(a)	
Power supply	230 V 50/60 Hz 9 W or 115 V 50/60 Hz 9 W (a)	
Electrical connection	Cable 3 x 1 mm <sup>2</sup>	
Marking	 II 3GD T4, in combination with SP3200(V)	
Connection	G 1/2" i at the buffer vessel	
Max. back purge pressure	6 bar abs.	
Volume buffer vessel	2 liters	
Ambient temperature	-20 to 55 °C [-4 to 131 °F]	
<b>Option 2-way-ball valve in the probe inlet</b>	<b>/VA</b>	
Part No.	20S9050	
Operating temperature	-20 up to 185°C [-4 up to 365 °F]	
<b>Option 2/3-way-ball valve in the probe inlet</b>	<b>/3VA</b>	
Part No.	20S9325	
Backflush/Test gas connection	6 mm tube	
Operating temperature	-20 up to +185 °C [-4 up to 365 °F]	

<b>Option pneum. drive for ball valve /VA o. /3VA</b>	<b>MS1</b>
Part No.	20S9055
Connection control air	G1/4" i

Pressure control air	5 to 10 bar	
<b>Option valve for blowback or calibration gas 1/4"</b>	<b>/R</b>	
Part No.	20S9045	
Opening pressure	> 0.7 bar	
Connection	6 mm tube	
Maximum blow back pressure	6 bar abs.	
Maximum operating temperature	+185 °C [365 °F]	
<b>Option high performance blow back valve</b>	<b>/BB</b>	<b>/BBF</b>
Part No.	20S9008	20S9006
Way of blow back gas	Via filter chamber	Via probe filter element
Check valve	High performance check valve 3/8"	
Opening pressure	> 0.7 bar	
Connection	8 mm tube	
Maximum blow back pressure	6 bar abs.	
Maximum operating temperature	185 °C [365 °F]	
<b>Option test gas valve / shut-off valve</b>	<b>/C + /I</b>	
Part No.	20S9011 + 20S9009	
Way of test gas	Via sample gas outlet with shut-off to the process	
Check valve	Check valve 1/4"	
Opening pressure	> 0.7 bar	
Connection	6 mm tube	
Shut-off valve	Bellow-type valve with pneumatic drive	
Pressure control air	3 to 10 bar	
Connection control air	1/8" NPT i	
<b>Option second sample gas outlet</b>	<b>/2X</b>	
Part No.	20S9015	
Connection	1/4" NPT i	

<b>Option spun glass cartridge</b>	<b>/FW</b>	
Part No.	20S9047	20S9046
Material	SS316Ti, Novapress®	SS316Ti, Graphite

\* Standard, \*\* Option

Novapress® is a registered trademark for elastomer-bonded gasket material used by the German company Frenzelit GmbH.

## 10.1 MAXIMUM SURFACE TEMPERATURE OF THE GAS SAMPLE PROBE:

The maximum surface temperature of the gas sample probe depends on the temperature of the process medium and the options used (heating **HEX5-x.08** and backflush **/RS**). Under no circumstances, the sample probes **SP3200(V)**... must exceed the maximum surface temperature fixed by the temperature class.



The maximum surface temperatures and inferable temperature classes of the gases are shown in the following table.

The intended use of the probe restricts the process medium temperature at the probe inlet and the choice of options to the extent that the maximum surface temperature must lie below the temperature limit given in table 5 for the combustible gases used or must correspond to the temperature class of the combustible gases used.

Gas sample probe SP3200(V) for gas sampling out of processes with combustible gases				
Variants	Identification	Max. medium temperature at the probe inlet [°C]	Max. surface temperature [°C]	Temperature class
SP3200(V)/HEX5-x.08 and all options	II 3 G	T2 – T5 Corresponding to the operating temperature of the selected temperature class for the heating, see table 5	T2 – T5 Corresponding to the limiter temperature of the selected temperature class for the heating, see table 5	T2 – T5 Corresponding to the selected temperature class for the heating, see table 5

**Table 4** Maximum surface temperatures for the use of heating HEX5-x.08

Temperature classes			
T-Class ATEX Cenelec/IEC/Nec 505	T-Class NEC 500	Operating temperature °C	Limiter °C
T2	T2	230 [446 °F]	235 [455 °F]
	T2A	215 [419 °F]	220 [428 °F]
T3	T3	185 [365 °F]	190 [374 °F]
	T3A	165 [329 °F]	170 [338 °F]
	T3B	150 [302 °F]	155 [311 °F]
	T3C	145 [293 °F]	150 [302 °F]
T4	T4	120 [248 °F]	125 [257 °F]
	T4A	105 [221 °F]	110 [230 °F]
T5	T5	85 [185 °F]	90 [194 °F]

**Table 5** Temperature classes for use of heating HEX5-x.08

## 11 RECEIPT OF GOODS AND STORAGE

- The probe and any special accessories should be unpacked carefully immediately upon delivery and checked against the delivery note for completeness.
- The delivery should be checked for transport damage and the transport insurer notified immediately of any damage.
- The gas sample probe is usually delivered in two packages:
  - gas sample probe with the necessary fastening bolts, nuts and flange gasket;
  - sample tube or preliminary filter – possibly with extension tube.



**Note**

The probe should be stored in a room protected from frost!

## 12 PREPARATIONS FOR INSTALLATION

First make sure that conditions at the intended place of use correspond to the data on the rating plate.

The temperature of the process must be taken into account when selecting the sampling point.

Heating of the probe above the temperature limit given in table 5 must be prevented.

**It must be ensured that the temperature class of the probe corresponds to the ignition temperatures of the combustible gases/vapors.**

Select the optimum sampling point in accordance with general guidelines or agree on a sampling point with the responsible authorities.



**Warning**



Place the sampling point in such a way that there is sufficient space for installation and removal of the probe. Do not forget to include the insertion length of the sample tube in your considerations.

Easy access to the probe must be ensured to facilitate later maintenance work.

The customer-side sample nozzle should be dimensioned so that the temperature of the nozzle is always above the process dew point to prevent corrosion and blockages.

If the ambient temperature in the nozzle area is higher than the maximum ambient temperature specified on the type plate due to radiant heat, a radiant heat reflection plate must be installed on site to protect the probe.

The mounting flange connection for the nozzle should be DN65 PN6. If another connection size is desired, an optional intermediate flange adapter **/SO10** is available.

The necessary minimum flange size or minimum nozzle diameter depends on the diameter of the sample tube or preliminary filter used.

The prevailing operating parameters must be checked against the following table prior to installation:

<b>Operating parameters for the combustible gas (SP3200(V))</b>			
Gas composition	<input type="checkbox"/> corrosive	<input type="checkbox"/> toxic	<input type="checkbox"/> explosive
Zone classification process side			
Zone classification environment			
Ignition temperature of the gases/vapours	°C (> max. surface temperature from table 4)	Corresponds to temperature class	
Explosion group	<input type="checkbox"/> IIA	<input type="checkbox"/> IIB	<input type="checkbox"/> IIC

<b>Process conditions</b>			
Low pressure/ excess pressure situation	mbar	mbar	
Process temperature	°C, min.	°C max.	
What parameters should be measured, eg. O <sub>2</sub> , CO, SO <sub>2</sub> , NOX,...	vol%	mg/Nm <sup>3</sup>	ppm
Required gas flow rate	l/h, min.	l/h, max.	
Necessary T90 time	sec.		

**Table 6** Operating parameters

### 13 INSTALLATION

The **M&C** probes **SP3200** und **SP3200V** have been developed for stationary use. With correct selection and installation, they will guarantee many years of trouble-free service with a minimum of maintenance.

We recommend a horizontal mounting position with the sample gas outlet showing downwards (this is not absolutely essential for proper functioning of the probe). The probe should be installed with an inclination of approximately 10° with respect to the process.



**Warning**

**Qualified personnel**



Work on the gas sample probe may only be carried out from QUALIFIED PERSONNEL when the process and environment have been declared explosion-free zones, i.e. they are free of explosive atmospheres.



The following procedure is recommended:

- Remove the probe cover after opening the two toggle-type fasteners.

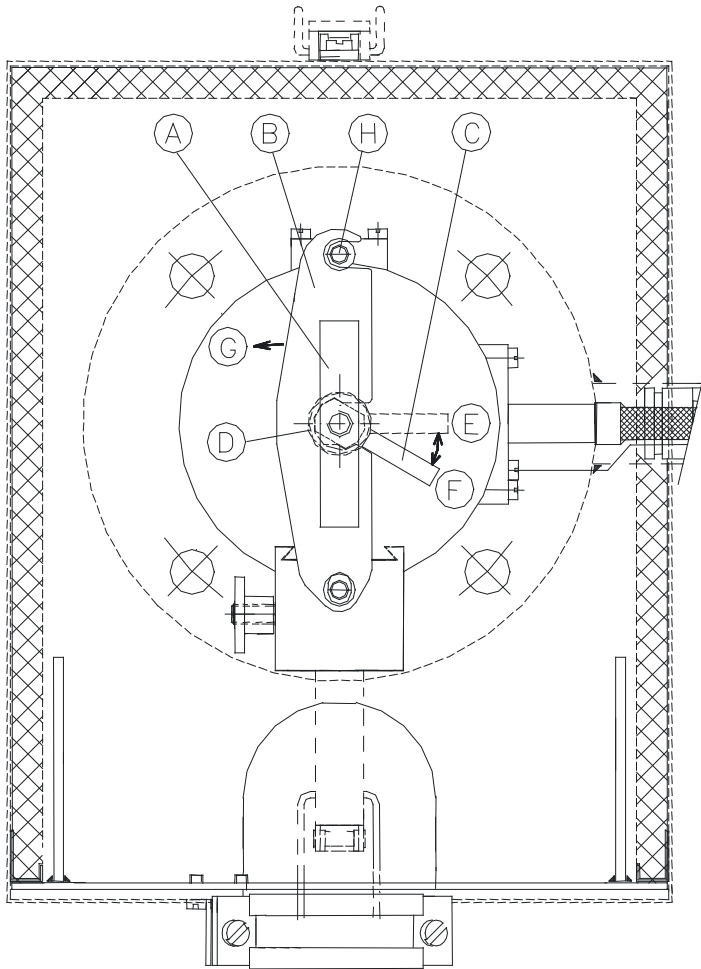

**Figure 4** Schematic drawing of the filter housing cover

- Turn handle **A** about one full turn anticlockwise so that the cover is lifted.
- Place handle **C** in position **E**.
- Swing out clamp **B** to the left (in the direction of **G**).
- Pull out the filter housing cover with handle **A**.

The following figures illustrate the steps described above.

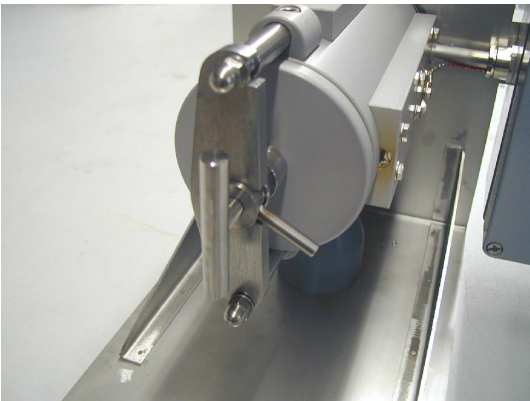
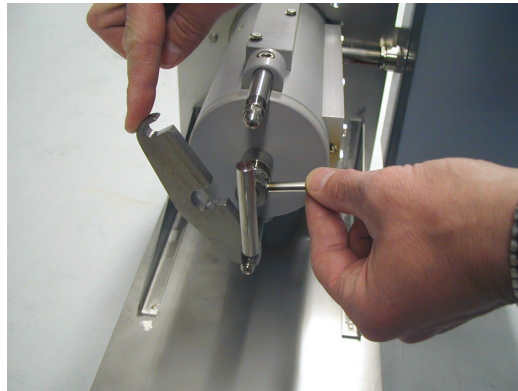

**Figure 5** Removal of the filter housing cover

- Check that the filter element is screwed on firmly.
- Insert the filter holder part again.

The filter holder part is closed in reverse order.

- Push the  $\frac{3}{4}$ " flat gasket on to the thread of the preliminary filter or extension tube, screw the filter or tube into the  $\frac{3}{4}$ " internal thread in the flange and tighten.

If the sample nozzle does not match with the size of the standard flange connection DN 65 PN 6, mount the optional flange adapter attached to the consignment on to the probe in the same way.

- Place the flange gasket on to the sample nozzle.
- Insert the complete probe unit into the process-side sample nozzle and screw tight with the nuts and bolts delivered.

### 13.1 CONNECTION OF THE SAMPLE LINE

- A ¼" NPT internal thread is provided on the probe side for connection of the sample line. Suitable connecting unions for explosion-protected lines in the sizes Ø 6 mm (standard), 8 mm or 10 mm can be screwed into this thread using PTFE sealing tape.



#### Warning

The fittings must be tightened carefully to avoid damaging the internal components. The fittings must not be overtightened.

In case of leaks, do not tighten the fittings further. Instead, the relevant fitting should be removed completely and then refitted.

Then check the connection for leaks.

The sample line is connected as follows:

- Loosen the toggle-type fasteners on the isolating cover and remove the cover.
- Loosen the thumb screw of the heat conducting plates and remove the plates.
- Screw a suitable union into the probe head using sealing tape.
- Remove the top part of the sample line mounting clamp and insert the sample line through the silicon cap in the bottom part of the bracket plate and into the union.
- Screw off the top part of the mounting clamp. In the case of larger sample line diameters it might be necessary for centric mounting of the sample line to move a little the small mounting bracket of the mounting clamp after having loosened the two screws and then tighten again.
- Connect the line to the union. For Swagelok® fittings:
  - Insert the line with supporting sleeve fully into the union.
  - Tighten the union nut finger-tight.
  - Before tightening, mark the union nut in 6 o'clock position.
  - Grip the body with a spanner and tighten the union nut by 1¼ turns; after a full turn, the marking must be turned further to 9 o'clock position.
- Then place the heat conducting plates in the guide slots on the side of the sample gas connection and tighten with the thumb screw.



#### Note

A supporting sleeve must always be used when connecting hose assemblies to stainless steel unions.

The connection must be checked for leaks.

When using the option backflushing unit /**RS** the corresponding line must be connected to the accumulator.

A backflushing gas suitable for the sampling point must be selected for backflushing.

The backflushing pressure must always be higher than the process pressure. This minimum pressure must be monitored at the inlet side of the accumulator with a pressure monitoring switch. If the flush gas pressure drops below the process pressure, the backflushing solenoid valve must not be operated.

**Warning**

At sampling points with inerting, backflushing must be performed with corresponding inert gas. It must be ensured that the inert gas does not introduce oxygen or combustible gases into the system.

The backflushing pressure must not exceed 6 bar abs.

Do not choose back flush intervals longer than 3 seconds because in case of strong pollution of the pre-filter pressure inside the probe would be rising and then discharging to the analyzer via the pressure control valve in the outlet of the probe due to a defined leak rate of this valve.

- Now, refit the cover and fasten it with the toggle-type fasteners.

The probe and all options must be earthed. The bleeder resistor must be  $< 10^6 \Omega$  everywhere.

**Warning**

The function of the probe must be monitored by a flow controller at the downstream analyser. A steady decline in the sample gas flow can be an indication of the need for maintenance work on the probe. The probe must be serviced when the flow rate drops below 50 %.

We also recommend the installation of an additional submicron filter in front of the analyser system.

- Further information can be found in the Internet at [www.mc-techgroup.com](http://www.mc-techgroup.com).

## 14 ELECTRICAL CONNECTION



**Warning**

A wrong supply voltage can damage the device. Make sure that the supply voltage corresponds to the voltage shown on the rating plate before connecting the device.



The requirements of VDE 0100 and its associated standards and regulations must be observed when erecting high-voltage power installations with rated voltages of up to 1000 V! In any case, we recommend the use of heat-resistant cables.

An external main switch must be provided.



For option **/RS**, the cable of the solenoid valve must be connected in a suitable Ex e connection box.

A fuse suitable for the rated current of the solenoid valve (max. 3xIB per DIN 41571 or IEC 127) or protective motor switch with short-circuit and thermal rapid release (set on the rated current) must be installed in front of the solenoid valve as short circuit protection.



**Warning**

The rated voltage of the fuse must be equal to or higher than the specified rated voltage of the solenoid valve. The breaking capacity of the fuse link must be equal to or higher than the maximum conceivable short circuit current at the place of installation (usually 1500 A). The fuse value is specified on the magnet coil.



**Fuse:**

**0.1 A for 230V/50 Hz**

**0.2 A for 115V/60 Hz**

**1 A for 24 V**



**Note**

The solenoid valve should be operated cyclically every 60 minutes (carry out min. 1 pulse/s).

Please read the electrical connection of the heating in the separate operating instructions of the heating **HEX5-x.08**.

## 15 STARTING-UP

The requirements of VDE 0100 and its associated standards and regulations must be observed when erecting high-voltage power installations with rated voltages of up to 1000 V.



An external main switch must be provided.

For option **/RS**, the control circuit of the solenoid valve must be protected with a 0.1 A<sub>T</sub> fuse for 230 V/50 Hz, a 0.2 A<sub>T</sub> fuse for 115 V/60 Hz or a 1 A fuse for 24 V.

Make sure that the supply voltage corresponds to the voltage shown on the rating plate before starting the device.

Switch on the power supply.

### Caution



In ambient temperatures greater than 40 °C [104 °F] the temperature at the protective or isolating cover is higher than 60 °C [140 °F].

## 16 MAINTENANCE



### When working during operation:

High surface temperatures!

Touching the surfaces can result in burns. Wear protective gloves.



Aggressive condensate possible!



Wear safety goggles and suitable protective clothing.



### Warning



The requirements of VDE 0100 and its associated standards and regulations must be observed when erecting and servicing high-voltage power installations with rated voltages of up to 1000 V!

**Warnung**

Work on the gas sample probe must only be carried out when the environment has been declared as non-hazardous area, i.e. it is free of explosive atmospheres.

The process side must also be declared as non-hazardous area – free of explosive atmospheres – before the filter chamber is opened.



The backflushing unit must be switched off before the filter chamber is opened.

The gas sample probe with preliminary filter and internal filter must be checked for temperature and dust deposits in suitable intervals of time depending on the process conditions. Dust layers of more than 5 mm must be removed immediately. The filters must be checked for damage and replaced if necessary. Also remove the dust deposits under the cover.



The probe must be shut down when the respective maximum surface temperature is exceeded.

The system and process-specific safety measures must be observed for all maintenance work.

Maintenance intervals cannot be recommended. They must be determined on site depending on the specific application and process conditions. An indication of the need for maintenance work on the probe can be a steady decline in the sample gas flow to the analyzer system.

## 16.1 REPLACEMENT OF THE FILTER ELEMENT

Maintenance of the probe is mainly limited to replacement of the filter elements and inspection of the seals and gaskets. For this:

- Remove the protective cover after opening the toggle-type fasteners.
- Dismount the filter holder part (see figure 3).
- Unscrew the filter thumb screw and replace the filter element.
- Inspect the filter element seals and replace them if necessary.
- Inspect the flat graphite gasket or Viton gasket in the cover and replace if necessary.
- Clean the filter chamber.
- Insert the filter holder part again and tighten hand-tight.
- Fit the protective cover.
- **Check tightness of the probe after each opening**

**Warning**

Possibly necessary spare gaskets must be out of graphite or Viton®.

## 16.2 REPLACEMENT OF THE PRELIMINARY FILTER

The complete probe unit must be removed from the process before replacing the preliminary filter. The preliminary filter can, depending on the type and degree of contamination, be cleaned mechanically or in an ultrasonic bath and is then reusable.

## 16.3 CLEANING OF THE PROBE

The gas sample probe must be inspected at suitable intervals in time. Dust layers of more than 5 mm must be removed immediately. The dust deposits under the cover must also be removed.



**Warning**

To prevent static charging, the probe should always be cleaned with a moist cloth.

## 17 SHUTDOWN

Before shutdown, i.e. switching off the heater, the probe should be flushed with a suitable inert gas to prevent condensation of aggressive components of the process gas.

## 18 PROPER DISPOSAL OF THE DEVICE

At the end of the service life of our products, it is important to take care of the appropriate disposal of obsolete electrical and non-electrical devices. To help protect our environment, follow the rules and regulations of your country regarding recycling and waste management.



## 19 SPARE PARTS LIST

Wear, tear and replacement part requirements depend on specific operating conditions. The recommended quantities are based on experience and they are not binding.

Gas sample probe SP3200 and SP3200V					
(C) Consumable parts					
(R) Recommended spare parts					
(S) Spare parts					
					Recommended quantity being in operation [years]
Part No.	Indication	C/R/S	1	2	3
90F0126	Filter element <b>F-3SS150</b> , 1.4404, 3 µm, 150 mm	C	6	12	18
90S0020	Filter element <b>S-2K150</b> , ceramic, 2 µm, 150 mm	C	6	12	18
93S0055	Gasket (30) for filter element, material graphite	R	4	8	12
93S0045	Alternatively: Gasket (30) for filter element, material Viton®	R	4	8	12
93S0020	O-ring (39) for lid SP3200V, material FKM	R	2	4	8
93S0025	O-ring (55) for lid SP3200V, material FKM	R	2	4	8
93S0030	Gasket (69) for lid SP3200, material graphite	R	2	4	8
90S2072	Gasket for sample tube, 3/4", material graphite	R	1	2	3
90S2084	Flange seal DN 65 PN 6 (67 mm i.), material graphite	R	1	1	1

## 20 ANNEX

- Drawing SP3200 RS, HEX5-1.08
- Drawing SP3200 RS, HEX5-2.08
- EU – Declaration of Conformity



Further product documentation can be found in the internet under: [www.mc-techgroup.com](http://www.mc-techgroup.com)

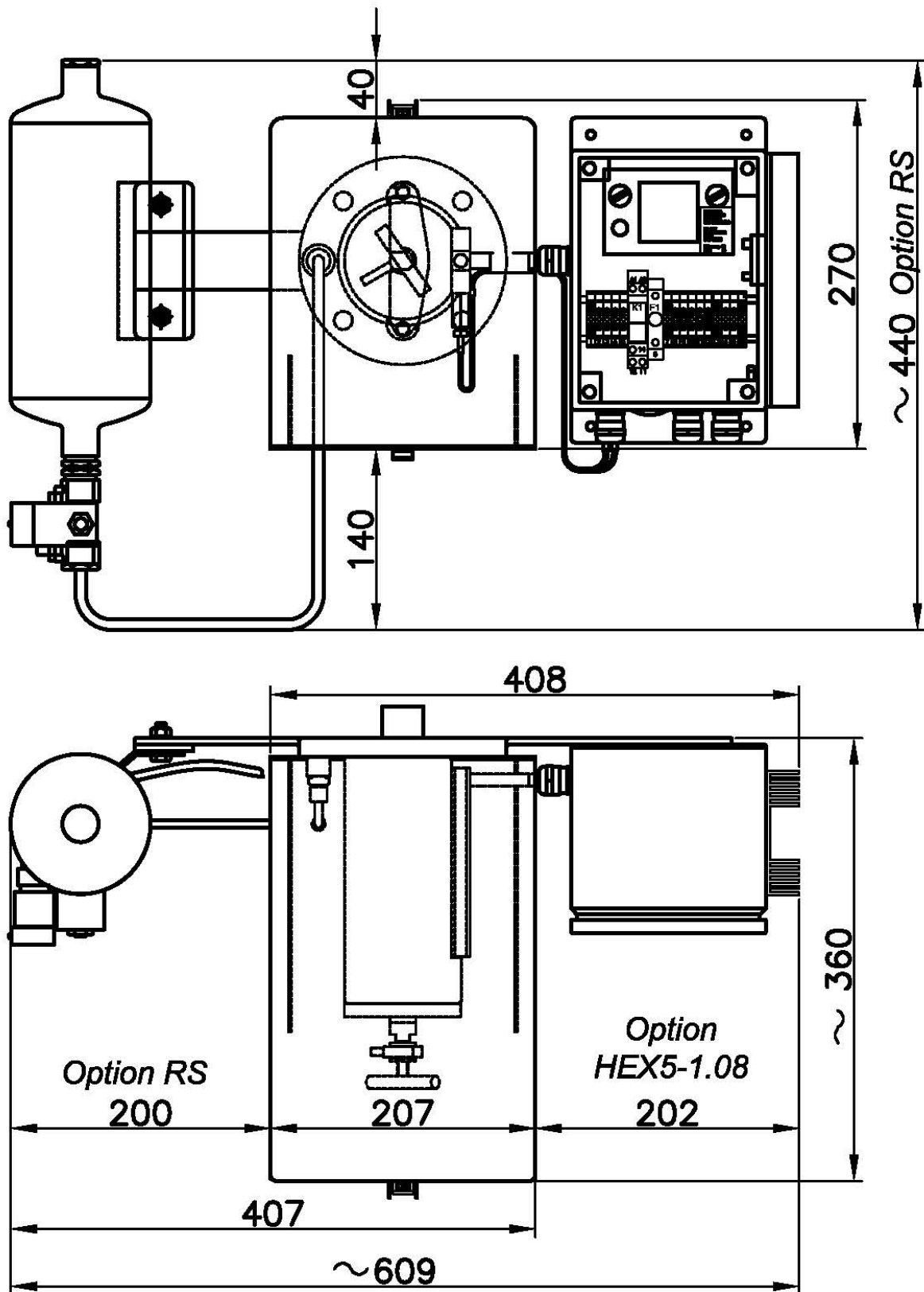

Figure 6 SP3200 RS, HEX5-1.08

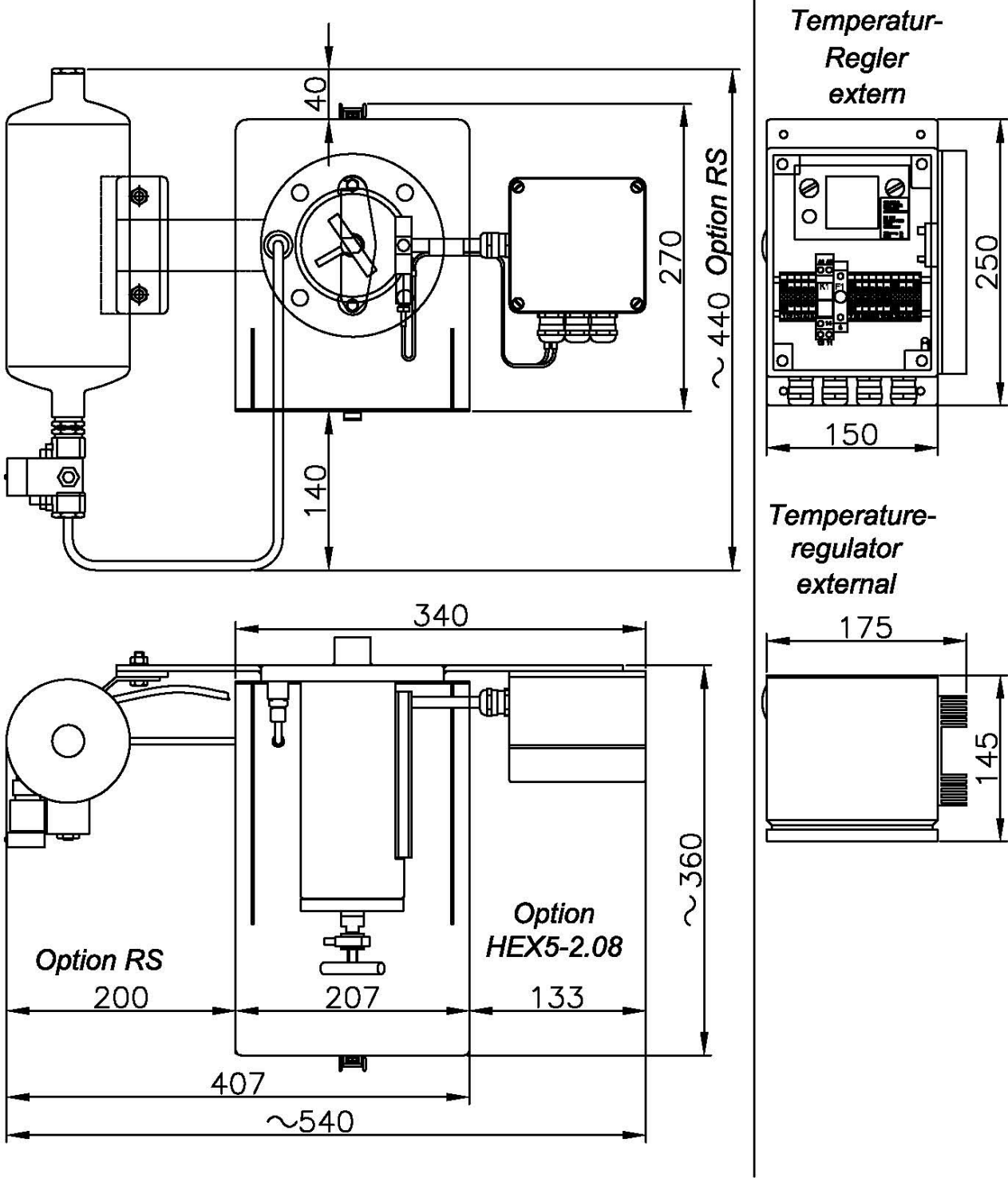

Figure 7 SP3200 RS, HEX5-2.08



## EU – Konformitätserklärung *EU Declaration of conformity*

im Sinne der Vorschriften nachfolgend genannter EU Richtlinien  
*according to the following EU directives*

Die **M&C TechGroup Germany GmbH** erklärt hiermit, dass nachfolgende Produktgruppen,  
 des Types  
*With this document, the M&C TechGroup Germany GmbH confirms, that the following  
 product types of these product groups*

Produktgruppen                      Sonde  
*Product groups                      Sample Probe*

Types                                      Typ SP3200    Anhang  
*Product types                              Typ SP3200    Appendix*  
 Dekra Certification B.V. 6825 MJ Arnhem, The Netherlands Nr.:0344

den grundlegenden Anforderungen der nachfolgenden Richtlinien entsprechen  
*comply with the essential requirements of the following directives*

EU-Richtlinie 2014/30/EU <i>EU-Directive 2014/30/EU</i>	Elektromagnetische Verträglichkeit (EMV) <i>Electromagnetic compatibility (EMC)</i>
EU-Richtlinie 2014/35/EU <i>EU-Directive 2014/35/EU</i>	Niederspannung <i>Low voltage (LVD)</i>
EU-Richtlinie 2014/34/EU <i>EU-Directive 2014/34/EU</i>	Explosionsschutz <i>ATEX directive</i>

Sowie die Übereinstimmung mit nachfolgenden Normen:  
*As well as in compliance with the following standards:*

<i>EN 61010-1:2010</i>	Überspannungskategorie II; Verschmutzungsgrad 2 <i>Overvoltage category II ; Pollution Degree 2</i>
<i>EN 60079-31:2015</i>	
<i>EN 60079-0: 2012+A11:2013</i>	<i>EN 1127-1 997</i>
<i>EN 60079-15: 2010</i>	<i>EN 13463-1 2004</i>
<i>EN 60079-7: 2015</i>	<i>BGR 132; 2003</i>

Ratingen, den 08.03.2016

**M&C TechGroup Germany GmbH**

Hans-Jörg Rumm  
 Rehnecke 79  
 D-40885 Ratingen  
 www.mc-techgroup.com

Hans-Jörg Rumm, Technical Director

Diese Erklärung bescheinigt die Übereinstimmung mit den genannten Richtlinien, beinhaltet jedoch keine Zusicherungen  
 von Eigenschaften im rechtlichen Sinne.

*This declaration certifies conformance with the above mentioned directives. Affirmation of attributes in a legal sense is not included.*

Die Sicherheitshinweise und Installationsanweisung der mitgelieferten Produktdokumentation sind zu beachten.

*The safety declarations and installation instruction of the accompanying product documentation need to be considered.*

CE Konformitätserklärung **96071\_10103**

Ursprungsdatum: **04.04.05**

M&C TechGroup Germany GmbH  
 Geschäftsführer Olaf Sommer  
 Rehnecke 79, 40885 Ratingen  
 Germany

Tel +49 2102 935-0  
 Fax +49 2102 935-111  
 info@mc-techgroup.com  
 www.mc-techgroup.com

Amtsgericht Düsseldorf  
 HRB 53843  
 USt-Ident-Nr. DE 814788475  
 WEEE-Reg.-Nr. DE 99278920

Stadtparkasse Düsseldorf  
 KTO 100 435 965 7 / BLZ 300 501 10  
 IBAN DE 32300501101004359657  
 BIC DUSS DE 33

M&C TechGroup  
 Gasentnahme- & Gasaufbereitungs-  
 technologie • Projektierung und  
 Bau von Analyse-Sondersystemen



## EU – Konformitätserklärung *EU Declaration of conformity*

### Gasentnahme Sonde SP3200

#### Anhang

Typ **SP3200** bestehend aus Gasentnahmesonde SP3200

mit den folgenden möglichen Optionen

<b>HEX5.1</b>	Heizung mit angebautem Regler	} II 3 G Ex nA nC nL IIC T2...T5 II 3 D Ex tD A22 IP65 T75°C – 235°C BVS 09ATEX E 107
<b>HEX5.2</b>	Heizung mit externem Regler	
<b>V/</b>	Gehäusedeckeldichtung Viton	
<b>VA/</b>	Absperrhahn 2-Wege mit Handantrieb im Eingang	
<b>3VA/</b>	Absperrhahn 3-Wege mit Handantrieb im Eingang	
<b>RS/</b>	Rückspülung mit Druckspeicher, Magnetventil, Rückschlagventil und Druckbegrenzungsventil im Messgasausgang	
<b>R/</b>	Rückspülung oder Prüfgasaufgabe über Rückschlagventil 1/4" für den Vorfilter	
<b>C/I</b>	Kalibriergasaufgabe über Rückschlagventil mit pneumatischen Absperrventil im Messgasausgang	
<b>BB/</b>	Rückspülung über Rückschlagventil 3/8" für den Vorfilter	
<b>BBF/</b>	Rückspülung über Rückschlagventil 3/8" für den Sondenfilter	
<b>CC/CCF</b>	Prüfgasaufgabe über Rückschlagventil vor oder hinter Sondenfilter durch den Betreiber wählbar	
<b>2X/</b>	Zweiter Messgasausgang	
<b>PT100</b>	Zusätzlicher PT100 mit Klemmenkasten	
<b>HP25</b>	Max. Druck 25bar	
<b>HP40 HP40K</b>	Max. Druck 40bar	
<b>D1/</b>	Max. Druck 25bar mit Druckreduzierung	

Die Gasentnahmesonde ist wie folgt gekennzeichnet: II 3 G Temperaturklasse: T2.. T5  
II 3 D Oberflächentemperatur: 235°C – 75°C

**Achtung!** Für den sicheren Betrieb sind die Bedienungsanleitung und die nachfolgenden besonderen Bedingungen unbedingt zu beachten.

#### Besondere Bedingungen für die sichere Anwendung

Mit der Sonde dürfen keine Gase oder Gasgemische entnommen werden, die auch bei Abwesenheit von Luft explosionsfähig sein können oder welche die sicherheitstechnisch relevanten Materialeigenschaften verändern. Weiterhin dürfen diese Gase oder Gasgemische keine Feststoffe enthalten, die in Kombination mit den Materialien der Sonde zündfähige Reib- oder Schlagfunken erzeugen können.

Die nachgeschaltete Analyse muss den Durchfluss des Messgases überwachen. Es sind geeignete Analysensysteme zu verwenden, deren Kategorie den Betriebsbedingungen entsprechen muss.

Die Gasentnahmesonden SP3200 und alle angebauten Optionen müssen sicher und dauerhaft geerdet werden. Der Ableitwiderstand muss einen Wert von  $< 10^6 \Omega$  gegenüber Erde aufweisen.

Ursprungsdatum: 04.04.05

Bei der Variante SP3200 mit Rückspülung muss der Rückspüldruck immer größer sein als der Prozessdruck. Dazu muss auf der Eingangsseite des Druckspeichers oder Rückschlagventil der Rückspüldruck überwacht werden. Bei einem Absinken des Rückspüldrucks unter den Prozessdruck darf das Rückspülmagnetventil nicht angesteuert werden.

Die maximale Oberflächentemperatur der Sonden hängt von der Temperatur des Prozessmediums und der elektrischen Betriebsmittel ab. Die Prozessmediumentemperatur bei der Option Heizung HEX5 beträgt maximal 235°C (siehe Betriebsanleitung). Die sich daraus ergebenden maximalen Oberflächentemperaturen und die daraus ableitbaren Temperaturklassen der zugelassenen Gase sind der Tabelle 1 zu entnehmen.

Bei Sonden ohne Heizung wird die Oberflächentemperatur durch den Prozess bestimmt bzw. durch das entnommene Medium. Die Aufheizung der Gasentnahmesonde durch die Medientemperatur darf die Temperatur der Temperaturklasse am Montageort in keinem Fall übersteigen. Die Temperaturklasse der Sonde ist durch den Betreiber zu bestimmen.

Tabelle 1: Zusammenhang zwischen Variante, Temperatur des Prozessmediums und der maximalen Oberflächentemperatur bzw. Temperaturklasse für Gase

<b>Gasentnahmesonde SP3200 zur Gasentnahme aus Prozessen mit brennbaren Gasen</b>				
Varianten	Kennzeichnung	Max. Prozessmediumentemperatur [°C]	Max. Oberflächentemperatur [°C]	Temperaturklasse
SP3200/HEX5.x Sonde mit Heizung HEX5 und allen möglichen Optionen	II 3 G II 3 D	T2..T5 Entsprechend der Betriebstemperatur der gewählten Temperaturklasse der Heizung siehe Tabelle 1.1	T2..T5 Entsprechend der Begrenzertemperatur der gewählten Temperaturklasse der Heizung siehe Tabelle 1.1	T2.. T5 Entsprechend der gewählten Temperaturklasse der Heizung siehe Tabelle 1.1
SP3200 ohne Heizung und allen möglichen Optionen				
SP3200	II 3 G	80	80	T6
SP3200	II 3 G	95	95	T5
SP3200	II 3 G	130	130	T4
SP3200	II 3 G	195	195	T3
SP3200	II 3 G	230	230	T2

	<p><b>Die Aufheizung der Gasentnahmesonde durch die Medientemperatur darf die Temperatur der Temperaturklasse am Montageort in keinem Fall übersteigen.</b></p>
---	---

Temperaturklassen der Heizung HEX5			
T.Class ATEX Cenelec/IEC/Nec 505	T.Class NEC 500	Operating temperature °C	Limiter °C
T2	T2	230	<=235
	T2A	215	<=220
T3	T2B	185	<=190
	T2C	175	<=180
	T2D	160	<=165
T3	T3	150	<=155
	T3A	135	<=140
	T3C	120	<=125
T4	T4	95	<=100
	T4A	85	<=90
T5	T5	70	<=75

Tabelle 1.1



Die Aufheizung der Gasentnahmesonde durch die Medientemperatur darf die Temperatur der Temperaturklasse am Montageort in keinem Fall übersteigen.

### Sample probe SP3200 Appendix

Type SP3200 consisting of gas sample probe SP3200

with the following possible options

<b>HEX5.1</b>	Heater with mounted controller	} II 3 G Ex nA nC nL IIC T2...T5 II 3 D Ex tD A22 IP65 T75°C – 235°C BVS 09ATEX E 107
<b>HEX5.2</b>	Heater with external controller	
<b>V/</b>	Sealing of casing cover out of Viton	
<b>VA/</b>	Stop valve 2-ways with manual actuation in the inlet	
<b>3VA/</b>	Stop valve 3-ways with manual actuation in the inlet	
<b>RS/</b>	Backflush unit with accumulator, solenoid valve, check valve and pressure control valve in the outlet of the sample gas	
<b>R/</b>	Backflushing or test gas feeding via check valve 1/4" for the preliminary filter	
<b>C/</b>	Calibration gas feeding via check valve with pneumatic stop valve in the sample gas outlet	
<b>BB/</b>	Backflushing via check valve 3/8" for the preliminary filter	
<b>BBF/</b>	Backflushing via check valve 3/8" for the probe filter	
<b>CC/CCF</b>	Feeding of test gas via check valve in front of or behind the probe filter to be selected by the user	
<b>2X/</b>	Second sample gas outlet	
<b>PT100</b>	Additional PT100 with terminal box	
<b>HP25</b>	Max. pressure 25 bar	
<b>HP40 HP40K</b>	Max. pressure 40 bar	
<b>D1/</b>	Max. pressure 25 bar with pressure reducer	

The gas sample probe is identified as follows: II 3 G Temperature class T2.. T5  
II 3 D Surface temperature 235°C – 75°C

**Attention!** In order to assure a safe operation, the operating instructions and the following special conditions are strictly to be followed.

#### Special conditions for a safe application

No gases or gas mixtures must be sampled with the probe that could be explosive in absence of air or that may change the material characteristics relevant for safety regulations. Further, these gases or gas mixtures must not contain solid particles that could produce explosive sparks due to friction or striking in combination with the materials of the probe.

The downstream analyse must control the debit of the sample gas. Suitable analyse systems have to be used, the category of which must comply with the operating conditions.

The gas sample probe SP3200 and all mounted options must be safely and permanently connected to earth. The derive resistance must show a value of  $< 10^6 \Omega$  in comparison to the earth.

In the variant SP3200 with backflushing, the backflush pressure must always be higher than the process pressure. For this purpose, the backflush pressure must be monitored on the inlet side of the accumulator or the check valve. In the event that the backflush pressure falls below the process pressure, the backflush solenoid valve must not be activated.

The maximum surface temperature of the probes depends on the temperature of the process medium and the electrical equipment. The temperature of the process medium with option heater HEX5 amounts to maximum 235°C (see operating manual). The respective maximum surface temperatures and the temperature classes of the admissible gases to be derived therefrom can be read in table 1:

In case probes are used without heater, the surface temperature is determined by the process or the sampled medium. The heating up of the gas sample probe through the medium temperature must never exceed the



temperature of the temperature class at the mounting location. The temperature class of the probe has to be determined by the user.

Table 1: The connection between variant, temperature of the process medium and the maximum surface temperature or temperature class for gases

<b>Gas sample probe SP3200 for gas sampling out of processes with fuel gases</b>				
Variants	Identification	Max. Process-medium temperature [°C]	Max. Surface temperature [°C]	Temperature class
SP3200/HEX5.x Probe with Heater HEX5 and all possible options	II 3 G II 3 D	T2..T5 According to the operating temperature of the chosen temperature class of the heater see table 1.1	T2..T5 According to the limiter temperature of the chosen temperature class of the heater see table 1.1	T2.. T5 According to the chosen temperature class of the heater see table 1.1
SP3200 without Heater and all possible options				
SP3200	II 3 G	80	80	T6
SP3200	II 3 G	95	95	T5
SP3200	II 3 G	130	130	T4
SP3200	II 3 G	195	195	T3
SP3200	II 3 G	230	230	T2

 **The heating up of the gas sample probe through the medium temperature must never exceed the temperature of the temperature class at the mounting location.**

<b>Temperature class of the heater HEX5</b>			
T.Class ATEX Cenelec/IEC/Nec 505	T.Class NEC 500	Operating temperature °C	Limiter °C
T2	T2	230	<=235
	T2A	215	<=220
T3	T2B	185	<=190
	T2C	175	<=180
	T2D	160	<=165
T3	T3	150	<=155
	T3A	135	<=140
	T3C	120	<=125
T4	T4	95	<=100
	T4A	85	<=90
T5	T5	70	<=75

Table 1.1

 **The heating up of the gas sample probe through the medium temperature must never exceed the temperature of the temperature class at the mounting location.**