

# Electric Gas Cooler Series ECP®

## ECPX000C

Instruction Manual

Version 1.01.00

Software Version 1.0



**Dear customer,**

Thank you for buying our product. In this manual you will find all necessary information about this M&C product. The information in the manual is fast and easy to find, so you can start using your M&C product right after you have read the manual.

If you have any question regarding the product or the application, please don't hesitate to contact M&C or your M&C authorized distributor. You will find all the addresses in the appendix of this instruction manual.

For additional information about our products, please go to M&C's website [www.mc-techgroup.com](http://www.mc-techgroup.com). There you can find the data sheets and manuals of our products in German and English.

This instruction manual does not claim to be complete and it may be subject to technical modifications.

© 05/2023 **M&C TechGroup** Germany GmbH. Reproduction of this document or its content is not allowed without permission from **M&C**.

With the release of this version all older manual versions will no longer be valid. The German instruction manual is the original instruction manual. In case of arbitration only the German wording shall be valid and binding.

**ECP®** is a registered trade mark.

Version: 1.01.00

Software version: 1.0

## List of Contents

<b>1</b>	<b>General Information</b> .....	<b>5</b>
<b>2</b>	<b>Declaration of Conformity</b> .....	<b>5</b>
<b>3</b>	<b>Safety Instructions</b> .....	<b>6</b>
<b>4</b>	<b>Warranty</b> .....	<b>6</b>
<b>5</b>	<b>Used Terms and Signal Indications</b> .....	<b>7</b>
<b>6</b>	<b>Application</b> .....	<b>9</b>
<b>7</b>	<b>Function of the M&amp;C Jet-Stream Heat Exchanger</b> .....	<b>10</b>
<b>8</b>	<b>Technical Data</b> .....	<b>11</b>
8.1	Dimensions .....	13
<b>9</b>	<b>Description</b> .....	<b>14</b>
9.1	Operating Modes and Monitoring Functions .....	14
9.2	Fan Speed Setting .....	14
9.3	Cooling Capacity, Inlet and Outlet Dew Point ECP1000C .....	15
9.4	Cooling Capacity, Inlet and Outlet Dew Point ECP2000C .....	17
9.5	Cooling Capacity, Inlet and Outlet Dew Point ECP3000C .....	19
<b>10</b>	<b>Operating Instructions</b> .....	<b>21</b>
10.1	Menu Structure ECP1000C and ECP3000C .....	21
10.2	Menu Structure ECP2000C .....	22
10.3	PIN Entry .....	23
10.4	Set Point Entry .....	24
10.5	Parameter Setting .....	25
10.5.1	Setting Temperature Alarm Limits .....	26
10.5.2	Resetting to Factory Settings .....	27
10.5.3	Brightness Setting of Display .....	28
<b>11</b>	<b>Receipt of Goods and Storage</b> .....	<b>28</b>
<b>12</b>	<b>Installation Instructions</b> .....	<b>29</b>
<b>13</b>	<b>Supply Connections</b> .....	<b>29</b>
13.1	Hose Connections .....	29
13.2	Electrical Connections .....	31
13.2.1	Power Supply Connection .....	31
13.2.2	Alarm Relais Connection .....	32
13.2.3	mA Output Connection for Cooler Block Temperature(s) (Optional) .....	32
13.2.4	mA Connection Thermocouple (Optional, ECP1000C Only) .....	33
13.2.5	LA Connection (Optional, Type LA1 or LA1S) .....	34
<b>14</b>	<b>Start-up</b> .....	<b>35</b>
14.1	Parameter Setting during Commissioning .....	35
<b>15</b>	<b>Closing Down</b> .....	<b>36</b>
<b>16</b>	<b>Maintenance</b> .....	<b>37</b>
16.1	Replacing a Heat Exchanger .....	37
16.2	Information on maintenance of the optionally installed peristaltic pump(s) .....	38
<b>17</b>	<b>Alarm and Error Messages</b> .....	<b>39</b>
<b>18</b>	<b>mA Output</b> .....	<b>40</b>
18.1	mA Output Range Selection .....	40
18.2	Calibrating a mA Output .....	41
<b>19</b>	<b>Liquid Alarm Sensor (LA) type LA1 and LA1S</b> .....	<b>42</b>
19.1	Activating the LA .....	43
19.2	LA Sensitivity adjustment .....	43
19.3	LA Calibration .....	44
<b>20</b>	<b>Retrofitting: Peristaltic Pump SR25.2-W</b> .....	<b>45</b>
<b>21</b>	<b>Proper disposal of the device</b> .....	<b>45</b>

<b>22</b>	<b>Spare Parts and Options list.....</b>	<b>46</b>
<b>23</b>	<b>Appendix .....</b>	<b>47</b>
23.1	Main Menu: ECP1000C and ECP3000C.....	48
23.2	Main Menu: ECP2000C .....	48
23.3	Menu Structure after Entering the PIN .....	49
23.4	Calculations for mA Output.....	49
23.4.1	Calculating the mA Value Based on the Temperature.....	49
23.4.2	Calculating the Temperature Based on the mA Value.....	50
23.4.3	Step Size and Resolution of the mA Output .....	50
23.5	Circuit Diagram .....	51
23.6	Wiring Diagram: Thermocouple Optional (ECP1000C) .....	52
23.7	Table of Parameter Codes .....	53
23.8	Quick Guide.....	55

## List of Figures

Figure 1	Application example ECPX000C .....	9
Figure 2	Diagram of the heat exchanger function.....	10
Figure 3	Dimensions .....	13
Figure 4	Borehole pattern.....	13
Figure 5	Electrical cooling capacity ECP1000C.....	15
Figure 6	Maximum inlet dew point ECP1000C.....	16
Figure 7	Outlet dew point ECP1000C.....	16
Figure 8	Electrical cooling capacity ECP2000C.....	17
Figure 9	Maximum inlet dew point ECP2000C.....	18
Figure 10	Outlet dew point ECP2000C.....	18
Figure 11	Electrical cooling capacity ECP3000C.....	19
Figure 12	Maximum inlet dew point ECP3000C.....	20
Figure 13	Outlet dew point ECP3000C.....	20
Figure 14	Navigating through the ECP1000C/ECP3000C main menu.....	21
Figure 15	Navigating through the ECP2000C main menu .....	22
Figure 16	Reaching the set point entry from the ECP1000C/ECP3000C main menu .....	25
Figure 17	Temperature alarm limits and hysteresis.....	26
Figure 18	Circuit diagram detail: power supply connection.....	31
Figure 19	Circuit diagram detail: alarm relay connection.....	32
Figure 20	Circuit diagram detail: mA output connection for cooler block temperature(s).....	33
Figure 21	Circuit diagram detail: LA connection.....	34
Figure 22	LA alarm limits .....	44
Figure 23	Dimensions SR25.2-W .....	45
Figure 24	Menu structure of a one channel cooler .....	48
Figure 25	Menu structure of the ECP2000C .....	48
Figure 26	Menu structure after entering the PIN .....	49
Figure 27	Circuit diagram .....	51
Figure 28	Wiring diagram: Thermocouple connection (ECP1000C) .....	52

## Head Office

**M&C TechGroup** Germany GmbH ♦ Rehhecke 79 ♦ 40885 Ratingen ♦ Germany  
Telephone: 02102 / 935 - 0  
Fax: 02102 / 935 - 111  
E - mail: [info@mc-techgroup.com](mailto:info@mc-techgroup.com)  
[www.mc-techgroup.com](http://www.mc-techgroup.com)

## 1 General Information

The product described in this instruction manual has been built and tested in our production facility.

All M&C products are packed to be shipped safely. To ensure the safe operation and to maintain the safe condition, all instructions and regulations stated in this instruction manual need to be followed. This instruction manual includes all information regarding proper transportation, storage, installation, operation and maintenance of this product by qualified personnel.

Follow all instructions and warnings closely.

Read this manual carefully before commissioning and operating the device. If you have any questions regarding the product or the application, please don't hesitate to contact M&C or your M&C authorized distributor.

## 2 Declaration of Conformity



The product described in this operating manual complies with the following EU directives:

### EMC-Instruction

The requirements of the EU directive 2014/30/EU "Electromagnetic compatibility" are met.

### Low Voltage Directive

The requirement of the EU directive 2014/35/EU "Low Voltage Directive" are met.  
The compliance with this EU directive has been examined according to DIN EN 61010.

### Declaration of conformity

The EU Declaration of conformity can be downloaded from the **M&C** homepage or directly requested from **M&C**.

### 3 Safety Instructions

#### **Follow these basic safety procedures when mounting, starting up or operating this equipment:**

Read this operating manual before starting up and use of the equipment. The information and warnings given in this operating manual must be heeded.

Any work on electrical equipment is only to be carried out by trained specialists as per the regulations currently in force.

The installation and commissioning of the device must conform to the requirements of VDE 0100 (IEC 364) 'Regulations on the Installation of Power Circuits with Nominal Voltages below 1000 V' and must be in compliance with all relevant regulations and standards.

For start-up, the mains plug must be connected first. The mains plug connects the device to ground.

For decommissioning and maintenance, first disconnect the alarm relay plug from the mains. Disconnect the mains plug last. The mains plug grounds the device until it is disconnected from the mains.

Check the details on the type plate to ensure that the equipment is connected to the correct mains voltage.

Protection against touching dangerously high electrical voltages:

Before opening the equipment, it must be switched off and hold no voltages. This also applies to any external control circuits that are connected.

The device is only to be used within the permitted range of temperatures and pressures.

Check that the location is weather-protected. It should not be subject to either direct rain or moisture.

Do not use the device in hazardous areas.

Installation, maintenance, inspections and any repairs of the devices must be carried out only by qualified skilled personnel in compliance with the current regulations.

### 4 Warranty

In case of a device failure, please contact immediately M&C or your M&C authorized distributor.

We have a warranty period of 12 months from the delivery date. The warranty covers only appropriately used products and does not cover the consumable parts. Please find the complete warranty conditions in our terms and conditions.

The warranty includes a free-of-charge repair in our production facility or the free replacement of the device. If you return a device to M&C, please be sure that it is properly packaged and shipped with protective packaging. The repaired or replaced device will be shipped free of delivery charges to the point of use.

## 5 Used Terms and Signal Indications



**Danger**

This means that death, severe physical injuries and/or important material damages **will occur** in case the respective safety measures are not fulfilled.



**Warning**

This means that death, severe physical injuries and/or important material damages **may occur** in case the respective safety measures are not fulfilled.



**Caution**

This means that minor physical injuries **may occur** in case the respective safety measures are not fulfilled.

**Caution**

Without the warning triangle means that a material damage may occur in case the respective safety measures are not met.

**Attention**

This means that an unintentional situation or an unintentional status may occur in case the respective note is not respected.



**Note**

These are important information about the product or parts of the operating manual which require user's attention.

**Qualified personnel**

These are persons with necessary qualification who are familiar with installation, use and maintenance of the product.



High voltages!

Protect yourself and others against damages which might be caused by high voltages.



Corrosive!

These substances destroy living tissue and equipment upon contact. Do not breathe vapors; avoid contact with skin and eyes.



Wear protective gloves!

Working with chemicals, sharp objects or extremely high temperatures requires wearing protective gloves.



Wear safety glasses!

Protect your eyes while working with chemicals or sharp objects. Wear safety glasses to avoid getting something in your eyes.



Wear protective clothes!

Working with chemicals, sharp objects or extremely high temperatures requires wearing protective clothes.



## 6 Application

The Peltier gas sample cooler type **ECPX000C** is used in analyzer sample system design to reduce the dew point of wet gases to a level that is stable and low. Sample gas cooling prevents subsequent condensation in the analyzer. The stability of the dew point is also extremely important as it helps to prevent water vapour cross sensitivity and volumetric error, especially in infrared analyzers.

The sample gas passes through a sampling probe to the type **ECPX000C** cooler where it is lowered to a dew point of +5 °C [41 °F]. Solids will have been trapped in the filter of the sample probe, (If provided in the type used) or are trapped in a downstream fine filter with optional liquid alarm sensor type LA1 or LA1S (evaluation of the sensor is integrated in the ECPX000C). The conditioned gas can now be passed to the analyzer.

If the downstream analyzer does not have gas quantity control/display, this must be done by an external device.

When feeding pressure-less gases, an external gas pump must be installed.

The condensate is discharged externally. For operations under pressure, an automatic condensate drain or collection vessel is used. For operations in partial vacuum (suction), a condensate vessel with a manual drain or a peristaltic pump for automatic condensate removal is used.



Note

**For protection against liquid breakthrough and to increase the dependability of the complete system we recommend the use of a liquid alarm sensor type LA1 or LA1S. The evaluation of the M&C liquid alarm sensor is integrated in the ECPX000C.**

The following figure shows the flow diagram of a typical application of the electric gas cooler **ECPX000C**.

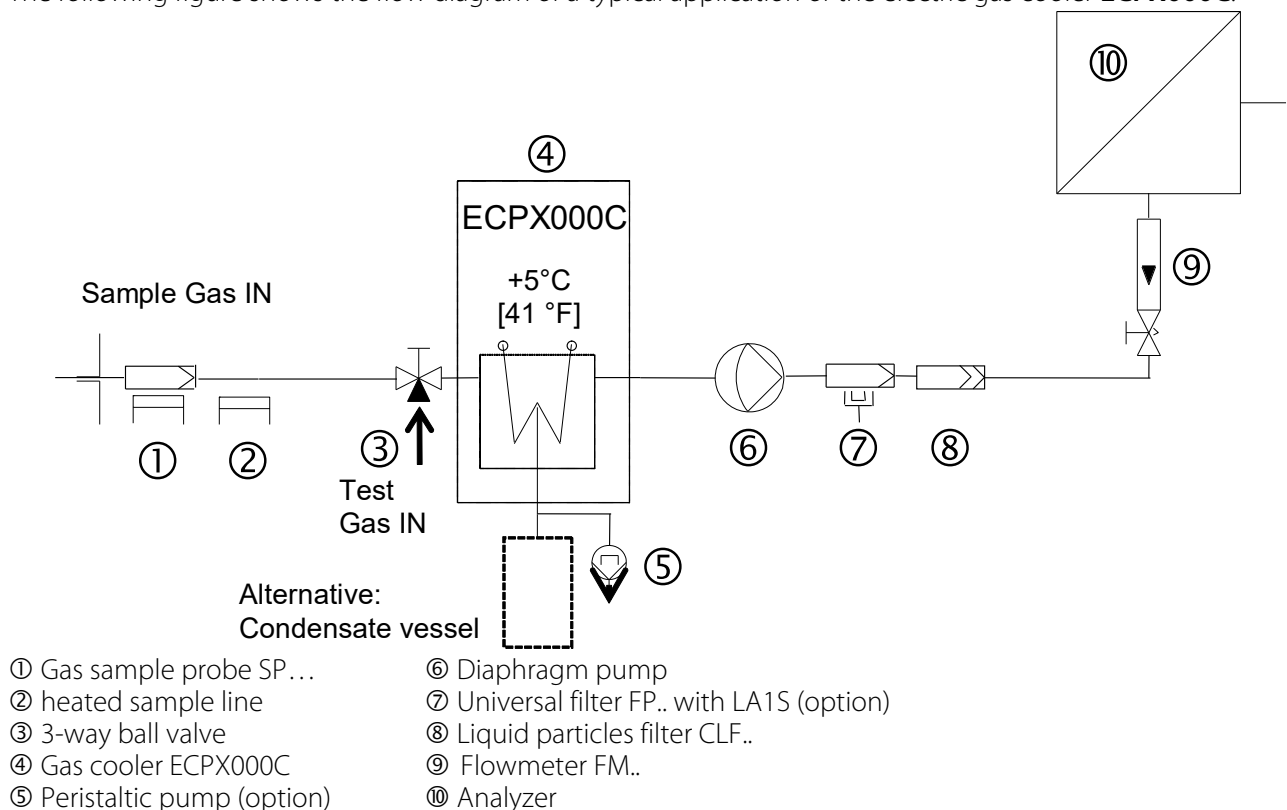

**Figure 1 Application example ECPX000C**

## 7 Function of the M&C Jet-Stream Heat Exchanger

The coolers **ECP1000C/2000C/3000C** with special design for analysis technique are prepared for maximum flow rates of 350 NI/h.

The Jet-Stream heat exchangers made of Duran glass, optional PVDF or stainless steel are located in a heat insulated cooling block. All the heat exchangers are easily accessible and are arranged in such a way that they can be removed very easily. Figure 2 shows a schematic diagram of the heat exchanger function.

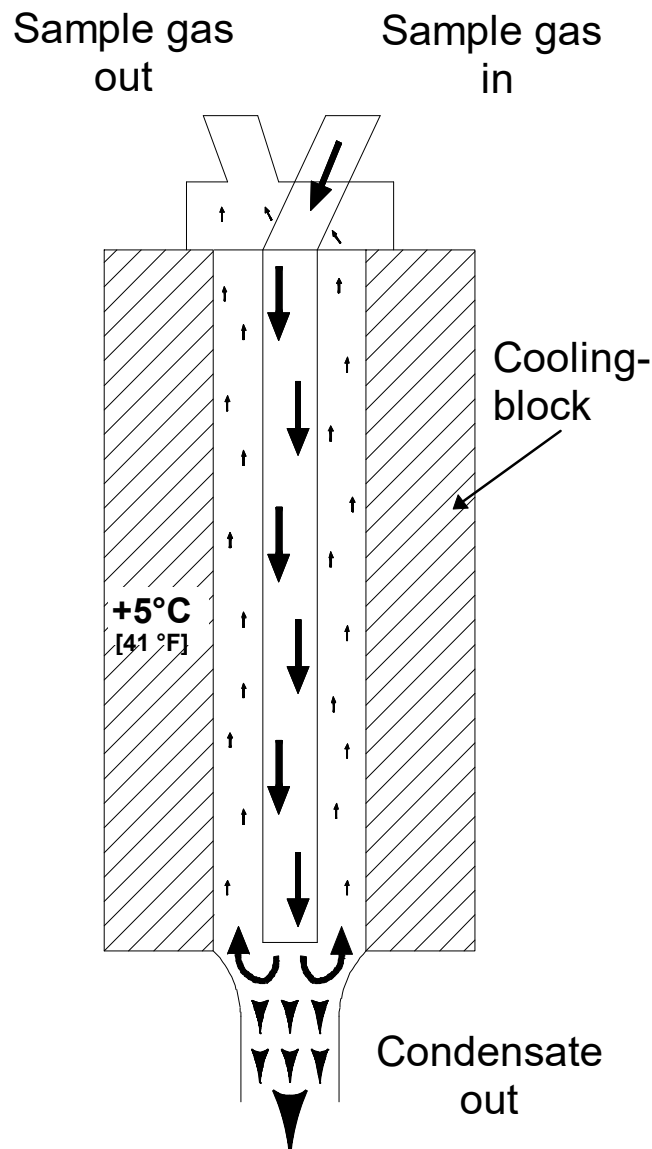

Figure 2 Diagram of the heat exchanger function

## 8 Technical Data

Electro Gas Cooler Version	ECP1000C	ECP2000C	ECP3000C
Part-No. without heat exchangers	01K1400x	01K2400x	01K3400x
Number of possible heat exchangers	1	2	1
Gas flow rate per heat exchanger	150 NI/h*	2 x 150 NI/h*	350 NI/h*
Ambient temperature	+5 to +50 °C [41 to 122 °F]		
Storage temperature	-20 to +60 °C [-4 to 140 °F]		
Sample outlet dew point	Range of adjustment: +2 to 15 °C [35.6 to 59 °F], factory setting: +5 °C [41 °F]		
Sample outlet dew point stability	At const. conditions: ±0.1 °C [±0.18 °F]		
Sample inlet temperature	Max. 180 °C* [356 °F*]		
Sample inlet water vapor saturation	Max. 80 °C* [176 °F*]		
Total cooling power at +25 °C [77 °F] ambient temperature	110 kJ/h	2 x 90 kJ/h	110 kJ/h
ΔP per heat exchanger at	1 mbar at 150 NI/h	1 mbar at 150 NI/h	5 mbar at 350 NI/h
Stagnant space per heat exchanger	50 ml	2 x 50 ml	100 ml
Power consumption	150 VA	275 VA	150 VA
Power supply	115 to 230 V ±10 %, 50/60 Hz		
Ready for use	< 3 min. (at 25 °C [77 °F] ambient temperature, no load applied)		
Max. loudness	58 dBA		
Electrical connection	Power: Pluggable via solenoid valve plug type A Alarm relay: Pluggable via solenoid valve plug type B mA: When purchasing the mA option, pluggable via Phoenix circular connector		
Signal input and output	One potential-free mA output per channel possible (max. burden 500 Ω, no shielding required) One M&C LA liquid alarm sensor type LA1 or LA1S can be connected per channel. The evaluation is integrated as standard.		
Status alarm: 2 changeover contacts	Max.: 250 V AC, 2 A, 500 VA Max.: 24 V DC, 2 A, 50 W <u>Note:</u> Inductive DC loads (e.g. relays, solenoid valves) may only be connected via flyback diodes.		
Case protection	IP20, EN 60529		
Electrical standard	EN 61010		
EMC standard	EN 61326		
Case colour	RAL 9003 (white)		
Method of mounting	Wall-mount		
Case dimensions (W x H x D)	300 x 200 x 225 mm [11.8" x 7.9" x 8.9"]		
Weight without heat exchangers	6.5 kg [14.3 lb]	8.2 kg [18.1 lb]	6.7 kg [14.8 lb]

\* Maximum values in technical data must be rated in consideration of total cooling capacity at 25 °C [77 °F] ambient temperature and an outlet dew point of 5 °C [41 °F].

Please note: NI/h and NI/min refer to the German standard DIN 1343 and are based on these standard conditions: 0 °C [32 °F], 1013 mbar.

Electric Gas Cooler type	ECP1000C/ECP2000C				
Heat exchanger type	ECM-2/ ECP(1/2)000C/EC C-1 G, WT	ECM-2/ ECP(1/2)000C/E CC-1 PV, WT	ECM-2/ ECP(1/2)000C/EC C-1 SS, WT	ECM-2/ ECP(1/2)000C/EC C-1 SS/NPT, WT	ECM-2/ ECP(1/2)000C/EC C-1 G/GL14, WT
Part No.	97K0100	97K0110	97K0115	97K0115NN	97K0101
Heat exchanger material	Duran® glass	PVDF	SS 316Ti	SS 316Ti	Duran® glass
Admissible gas pressure.	Max. 3 bar abs. <sup>1)</sup> (2 bar abs. <sup>2)</sup> )	Max. 3 bar abs. (2 bar abs. <sup>2)</sup> )	Max. 10 bar abs. (2 bar abs. <sup>2)</sup> )	Max. 10 bar abs. (2 bar abs. <sup>2)</sup> )	Max. 3 bar abs. <sup>1)</sup> (2 bar abs. <sup>2)</sup> )
Sample gas connection	GL18 for tube Ø 6 mm OD	Tube Ø 6 mm	Tube Ø 6 mm	1/4" tube	GL18 for tube Ø 6 mm OD; GL14 for sensor
Condensate connection	GL25 for tube Ø 12 mm, Ø 8 mm* or Ø 10 mm*	G3/8"i	G3/8"i	3/8"NPT	GL25 for tube Ø 12 mm, Ø 8 mm* oder Ø 10 mm*

Electric Gas Cooler type	ECP3000C			
Heat exchanger type	ECM-1/ ECP3000(C)/ ECC-1 G, WT	ECM-1/ ECP3000(C)/ ECC-1 PV, WT	ECM-1/ ECP3000(C)/ ECC-1 SS, WT	ECM-1/ ECP3000(C)/ ECC-1 SS/NPT, WT
Part No.	93K0140	93K0170	93K0160	93K0160N
Heat exchanger material	Duran® glass	PVDF	SS 316Ti	SS 316Ti
Admissible gas pressure	Max. 3 bar abs. <sup>1)</sup> (2 bar abs. <sup>2)</sup> )	Max. 3 bar abs. (2 bar abs. <sup>2)</sup> )	Max. 10 bar abs. (2 bar abs. <sup>2)</sup> )	Max. 10 bar abs. (2 bar abs. <sup>2)</sup> )
Sample gas connection	GL18 for tube Ø 6 mm OD	G1/4" female	G1/4" female	1/4" NPT
Condensate connection	GL25 for tube Ø 12 mm, Ø 8 mm* or Ø 10 mm*	G3/8" female	G3/8" female	3/8"NPT

\* Option

1) With GL adapter

2) With peristaltic pump SR25.2-W

### 8.1 Dimensions

Figure 3 shows the **ECP2000C** cooler unit.

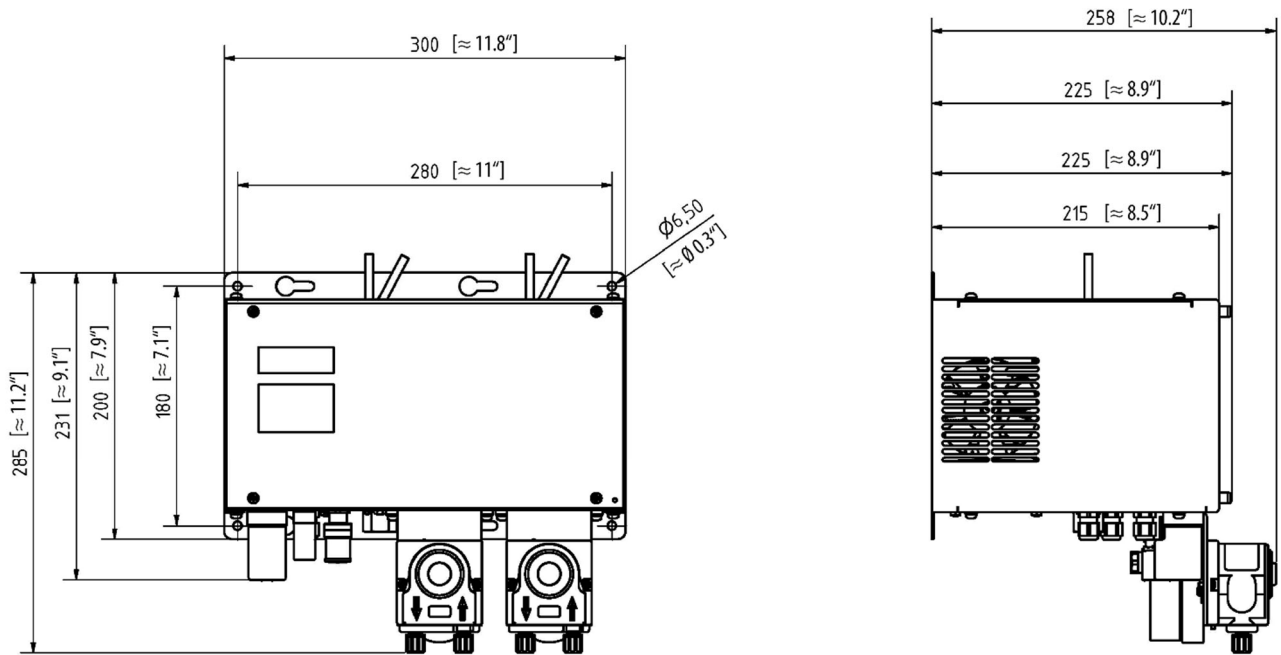

**Figure 3** Dimensions

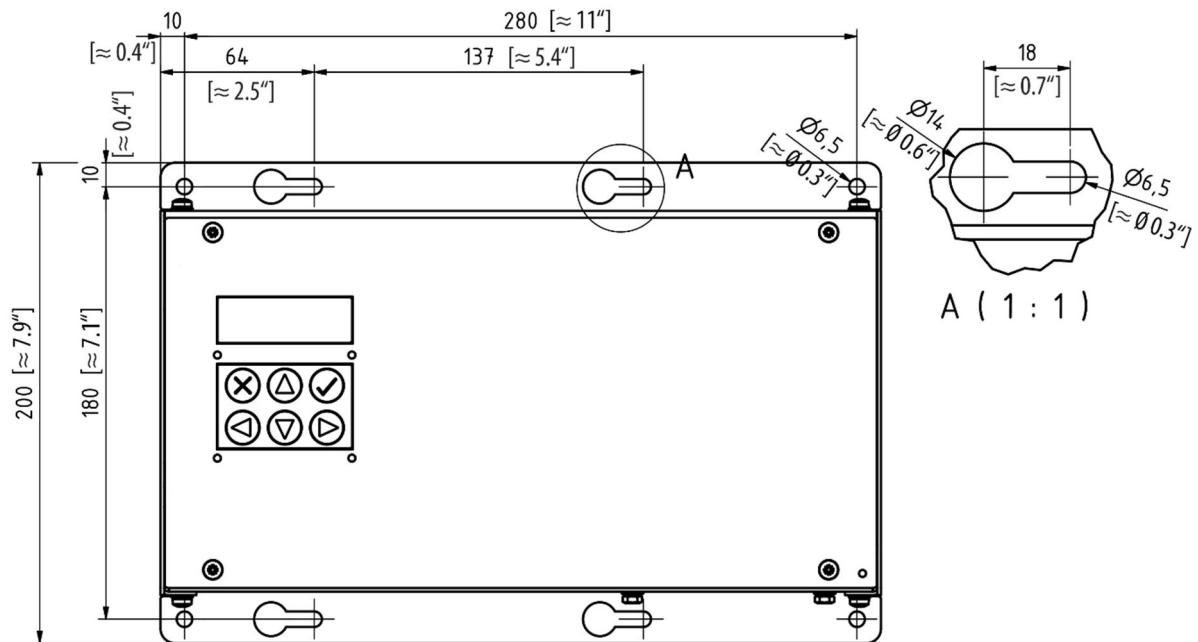

**Figure 4** Borehole pattern

## 9 Description

The gas coolers ECP1000C/2000C/3000C have been specially developed for the analysis technology. All ECPX000C gas coolers are available with Duran glass, PVDF or stainless steel 316Ti Jet-Stream heat exchangers.

The ECP1000C cools a gas path with a maximum gas flow of 150 NI/h. The ECP 2000C can be equipped with up to two heat exchangers. This makes it possible to cool two gas paths with a maximum volume flow of 2 x 150 NI/h. The ECP3000C is used for cooling a gas path with a gas flow rate of up to 350 NI/h max.

The heat exchangers are located in a heat-insulated cooling block and are easily replaceable.

The cooling block is cooled to a constant temperature of +5 °C [41 °F] by an electronically controlled Peltier element.

The excess thermal energy of the cooling system is dissipated via a large cooling fin block which is forced ventilated by a fan.

### 9.1 Operating Modes and Monitoring Functions

The ECPX000C gas cooler can be operated in two modes. In the first operating mode, the cooler temperature can be set as an absolute value and in the second mode as the differential temperature to the ambient temperature. The display shows the respective operating mode with an "A" for absolute value control and a small "d" for differential temperature control when setting the setpoint.

With the two-channel ECP2000C, both operating modes can be used, i.e. one of the heat exchangers can be controlled to absolute temperature and the other to differential temperature independently of each other.

The cooler has several monitoring functions. In addition to the cooler temperatures, it monitors the fan rotation and optionally connected liquid alarm sensors. Occurring alarm or error messages are shown on the display. The alarm limits can be configured so that the limit values can be adapted to the corresponding application.

### 9.2 Fan Speed Setting

The ECPX000C is equipped with a large cooling fin block which is forced-ventilated by a fan. The minimum speed of the fan can be changed without affecting the final performance of the cooler. The setting range is between 0 and 5 and level 1 is set by default. At level 0 the fan rotates slower and is quieter. At higher values, the fan rotates faster and the air flow rate is increased.

If the ECPX000C is installed in a cabinet, two fan grilles are recommended: for fresh air on the suction side of the cooler and for exhaust air. It is also recommended to increase the fan speed to level 3.

### 9.3 Cooling Capacity, Inlet and Outlet Dew Point ECP1000C

The following diagram shows the cooling capacity of the ECP1000C as a function of the ambient temperature. The continuous characteristic curve shows the electrical cooling capacity of the cooler without taking the heat exchanger properties into account.

The thermal conductivity of the heat exchanger materials has a significant influence on how much of the possible cooling capacity can be transferred from the cooler to the sample gas.

The dashed lines represent the characteristic curves of the heat exchangers. The characteristic curves of the heat exchangers require good lubrication, i.e. the best possible heat transfer.

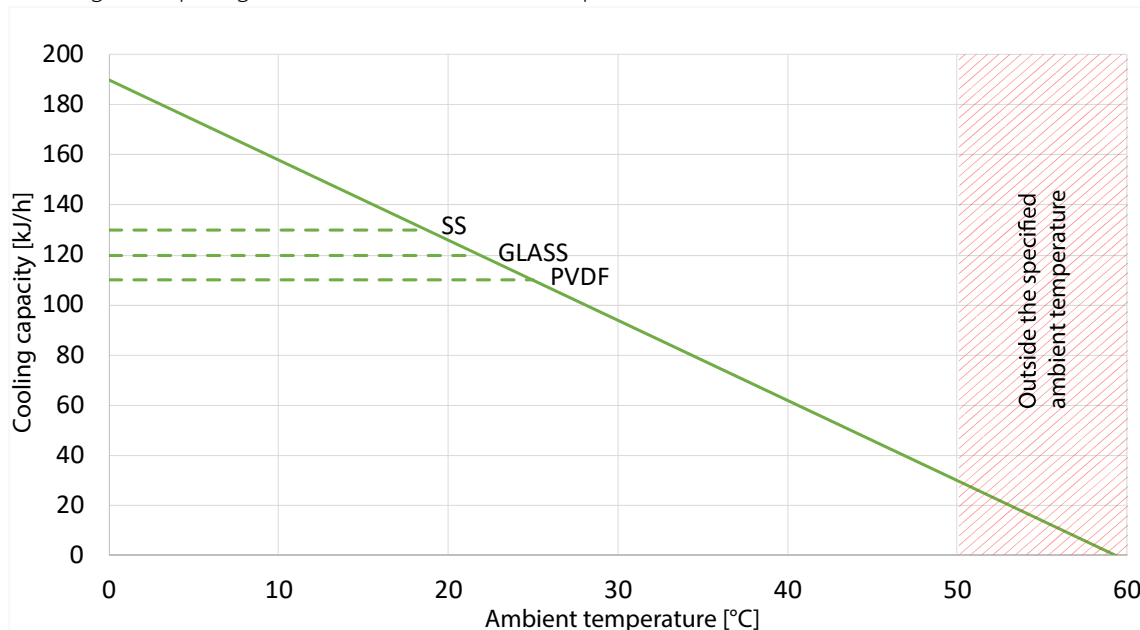

**Figure 5 Electrical cooling capacity ECP1000C**

The following figure shows the max. inlet water vapor dew point (with a Ø 25 mm heat exchanger) of the ECP1000C as a function of the gas flow.

Calculating the energy in a gas is very complex. The energy content extracted from the sample gas is determined by three main parameters:

- Temperature,
- dew point and
- flow velocity of the sample gas.

Fixed parameters in the diagram are the gas temperature (180 °C [356 °F]), the cooler temperature (5 °C [41 °F]) and the sample gas (air). The flow rate is measured after the cooler.

If the process now specifies, for example, a water vapor with a dew point of 50 °C [122 °F], the approximate maximum possible flow rate at which the cooler is not yet overloaded can be read from the diagram. To do this, one has to always stay below the respective characteristic curve which corresponds to the prevailing ambient temperature.

The upper characteristic curve in the diagram ( $T_{\text{ambient}} = 20\text{ °C}$  [68 °F]) represents the maximum water vapor inlet dew point as a function of the flow rate. Higher values cannot be achieved by further reducing the ambient temperature.

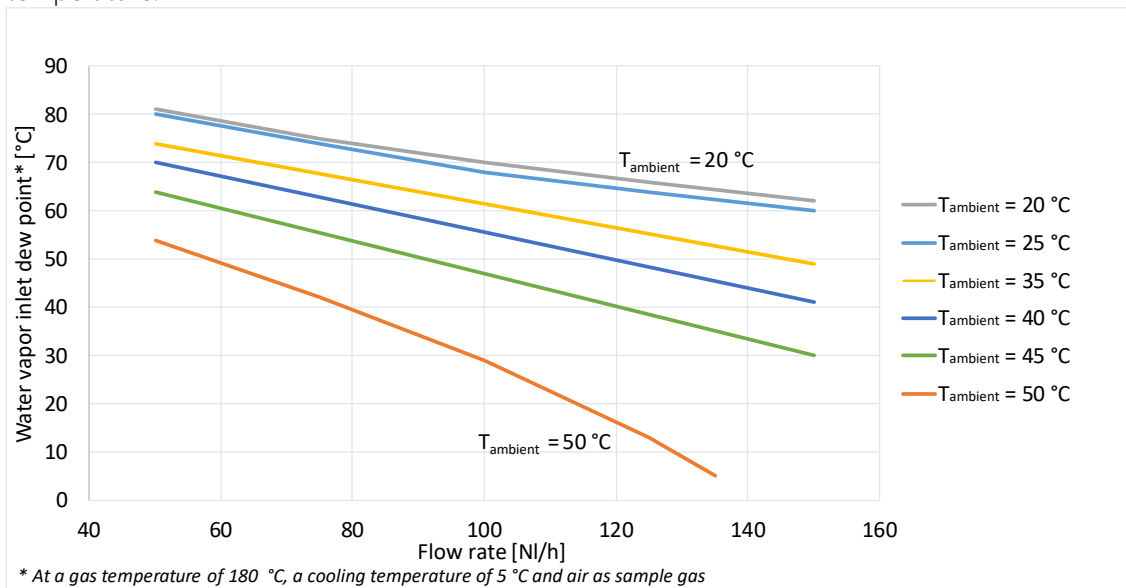

**Figure 6 Maximum inlet dew point ECP1000C**

The next diagram shows the heat exchanger-dependent gas outlet dew point as a function of the flow rate. Fixed parameters in the diagram are the gas inlet temperature (180 °C [356 °F]) and the water vapor inlet dew point: (60 °C [140 °F]). The flow rate is measured after the cooler.

The more energy there is in the sample gas, the more losses occur during heat transfer from the sample gas via the heat exchanger to the cooling block of the cooler. This is a physical effect.

The better the thermal conductivity of the heat exchanger material, the lower this effect. This diagram can be used to estimate and schedule this effect.

Since the effect is strongly dependent on the flow rate, it is recommended to keep the flow rate constant and to select only the maximum flow rate required by the process. The minimum and maximum permissible flow rate of the heat exchangers must be taken into account.

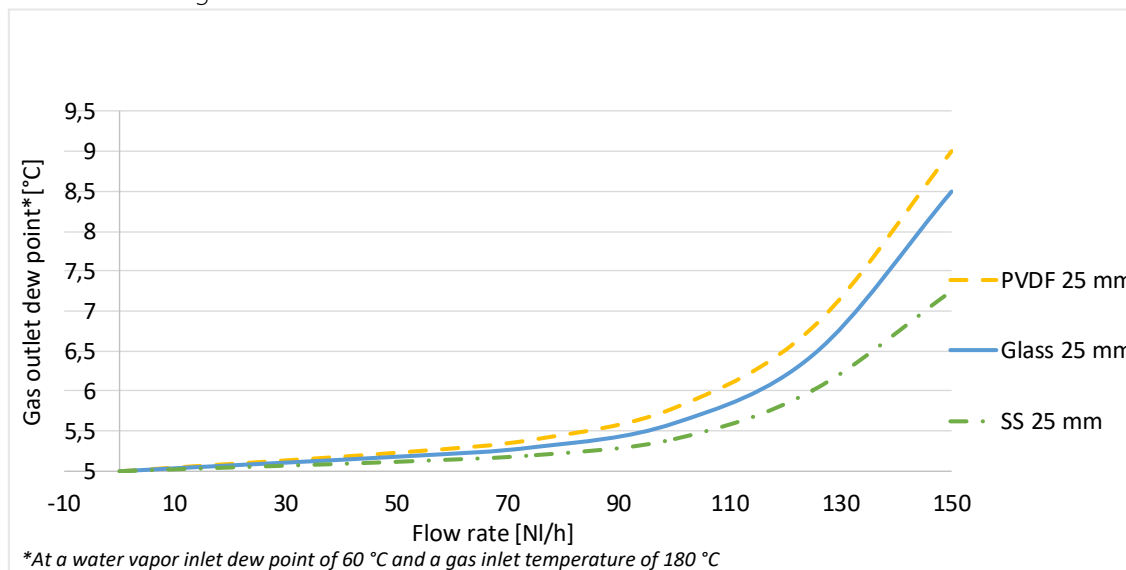

**Figure 7 Outlet dew point ECP1000C**



## 9.4 Cooling Capacity, Inlet and Outlet Dew Point ECP2000C

The following diagram shows the cooling capacity of the ECP2000C as a function of the ambient temperature. The continuous characteristic curve shows the electrical cooling capacity of the cooler without taking the heat exchanger properties into account.

The thermal conductivity of the heat exchanger materials has a significant influence on how much of the possible cooling capacity can be transferred from the cooler to the sample gas.

The dashed lines represent the characteristic curves of the heat exchangers. The characteristic curves of the heat exchangers require good lubrication, i.e. the best possible heat transfer.

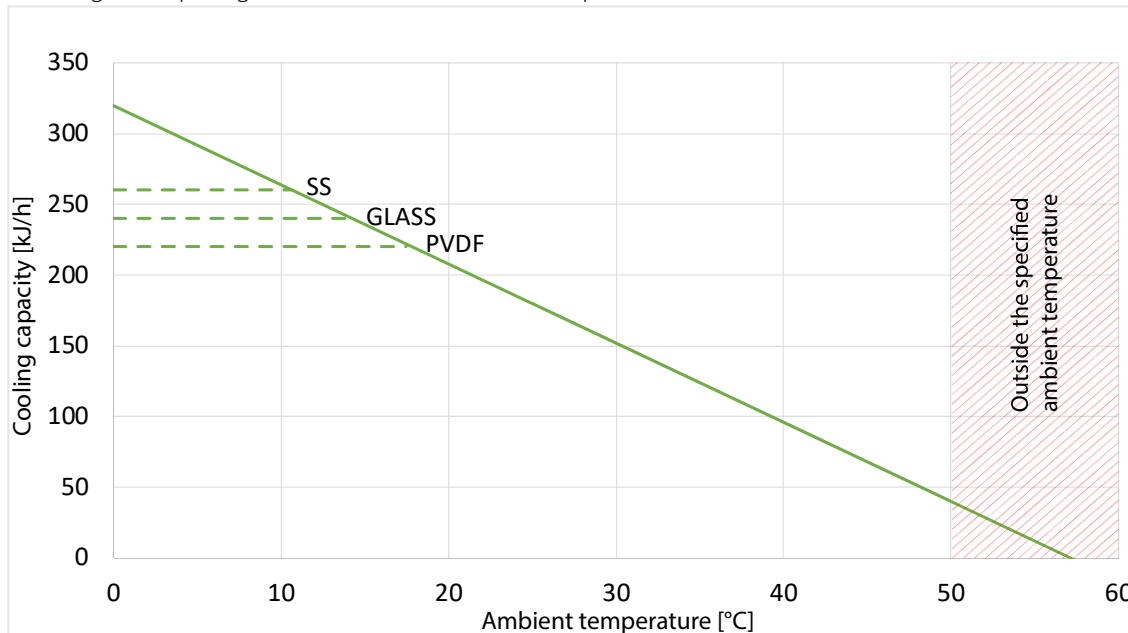

**Figure 8 Electrical cooling capacity ECP2000C**

The following figure shows the max. inlet water vapor dew point (with a Ø 25 mm heat exchanger) of the ECP2000C as a function of the gas flow.

Calculating the energy in a gas is very complex. The energy content extracted from the sample gas is determined by three main parameters:

- Temperature,
- dew point and
- flow velocity of the sample gas.

Fixed parameters in the diagram are the gas temperature (180 °C [356 °F]), the cooler temperature (5 °C [41 °F]) and the sample gas (air). The flow rate is measured after the cooler.

If the process now specifies, for example, a water vapor with a dew point of 50 °C [122 °F], the approximate maximum possible flow rate at which the cooler is not yet overloaded can be read from the diagram. To do this, one has to always stay below the respective characteristic curve which corresponds to the prevailing ambient temperature.

The upper characteristic curve in the diagram ( $T_{\text{ambient}} = 10\text{ °C}$  [50 °F]) represents the maximum water vapor inlet dew point as a function of the flow rate. Higher values cannot be achieved by further reducing the ambient temperature.

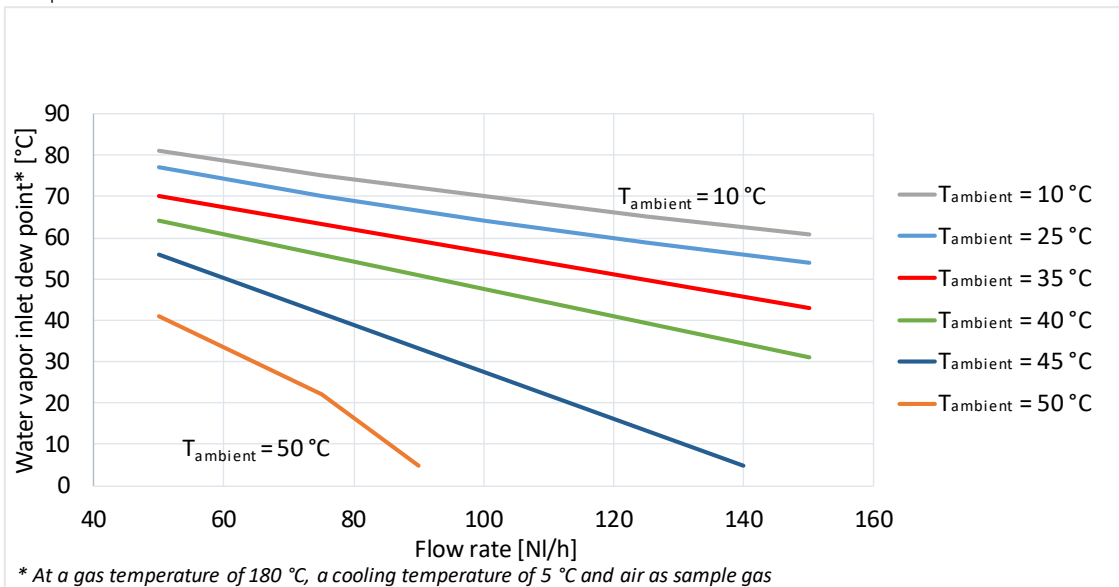

**Figure 9 Maximum inlet dew point ECP2000C**

The next diagram shows the heat exchanger-dependent gas outlet dew point as a function of the flow rate: Fixed parameters in the diagram are the gas inlet temperature (180 °C [356 °F]) and the water vapor inlet dew point: (60 °C [140 °F]). The flow rate is measured after the cooler.

The more energy there is in the sample gas, the more losses occur during heat transfer from the sample gas via the heat exchanger to the cooling block of the cooler. This is a physical effect.

The better the thermal conductivity of the heat exchanger material, the lower this effect. This diagram can be used to estimate and schedule this effect.

Since the effect is strongly dependent on the flow rate, it is recommended to keep the flow rate constant and to select only the maximum flow rate required by the process. The minimum and maximum permissible flow rate of the heat exchangers must be taken into account.

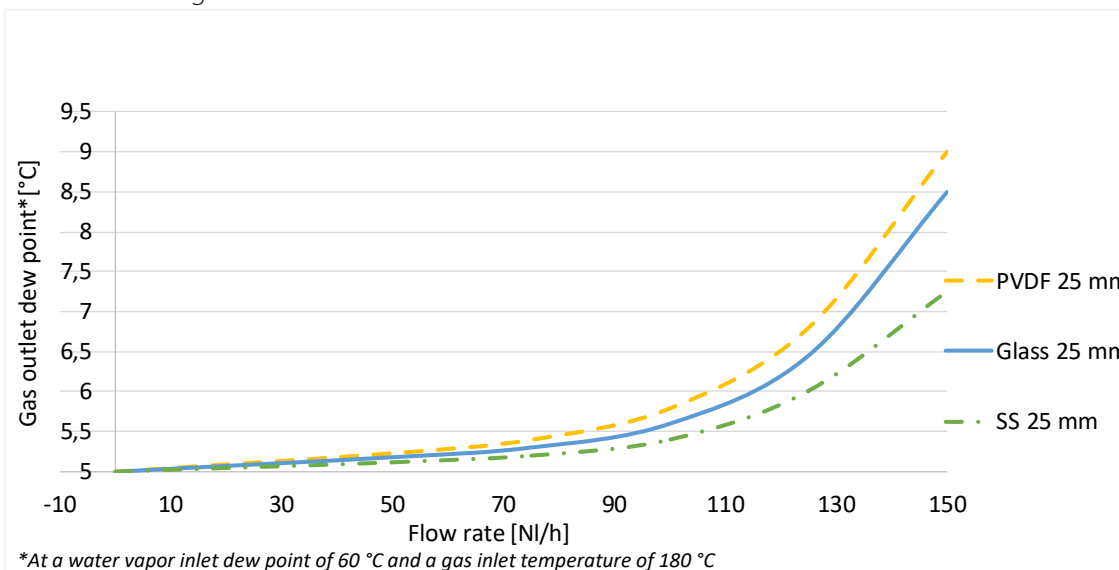

**Figure 10 Outlet dew point ECP2000C**

## 9.5 Cooling Capacity, Inlet and Outlet Dew Point ECP3000C

The following diagram shows the cooling capacity of the ECP3000C as a function of the ambient temperature. The continuous characteristic curve shows the electrical cooling capacity of the cooler without taking the heat exchanger properties into account.

The thermal conductivity of the heat exchanger materials has a significant influence on how much of the possible cooling capacity can be transferred from the cooler to the sample gas.

The dashed lines represent the characteristic curves of the heat exchangers. The characteristic curves of the heat exchangers require good lubrication, i.e. the best possible heat transfer.

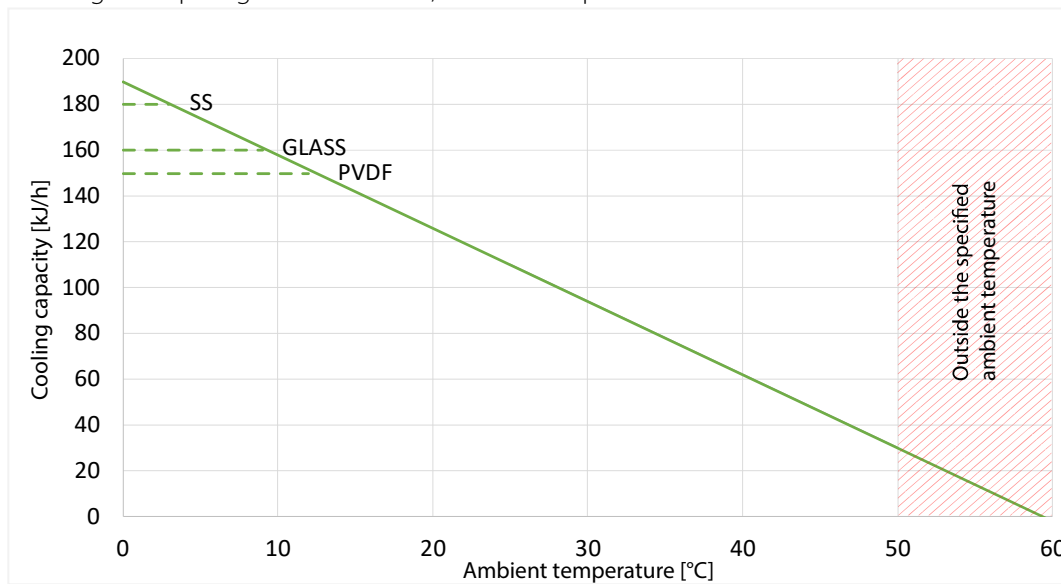

**Figure 11 Electrical cooling capacity ECP3000C**

The following figure shows the max. inlet water vapor dew point (with a Ø 50 mm glass heat exchanger) of the ECP3000C as a function of the gas flow.

Calculating the energy in a gas is very complex. The energy content extracted from the sample gas is determined by three main parameters:

- Temperature,
- dew point and
- flow velocity of the sample gas.

Fixed parameters in the diagram are the gas temperature (180 °C [356 °F]), the cooler temperature (5 °C [41 °F]), and the sample gas (air). The flow rate is measured after the cooler.

If the process now specifies, for example, a water vapor with a dew point of 50 °C [122 °F], the approximate maximum possible flow rate at which the cooler is not yet overloaded can be read from the diagram. To do this, one has to always stay below the respective characteristic curve which corresponds to the prevailing ambient temperature.

The upper characteristic curve in the diagram ( $T_{\text{ambient}} = 10\text{ °C}$  [50 °F]) represents the maximum water vapor inlet dew point as a function of the flow rate. Higher values cannot be achieved by further reducing the ambient temperature.

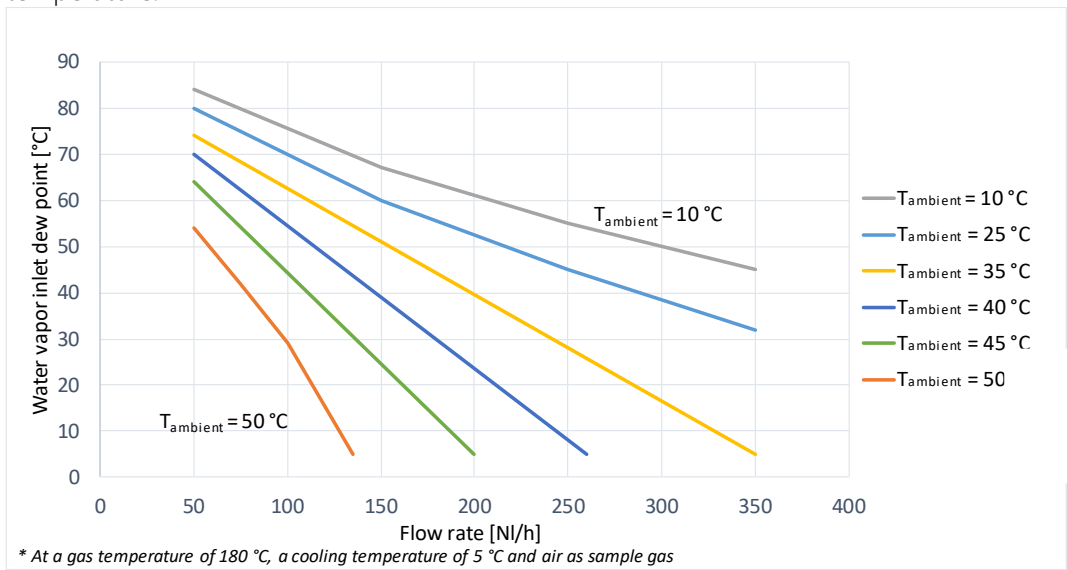

**Figure 12 Maximum inlet dew point ECP3000C**

The next diagram shows the heat exchanger-dependent gas outlet dew point as a function of the flow rate: Fixed parameters in the diagram are the gas inlet temperature (180 °C [356 °F]) and the water vapor inlet dew point: (45 °C [113 °F]). The flow rate is measured after the cooler.

The more energy there is in the sample gas, the more losses occur during heat transfer from the sample gas via the heat exchanger to the cooling block of the cooler. This is a physical effect.

The better the thermal conductivity of the heat exchanger material, the lower this effect. This diagram can be used to estimate and schedule this effect.

Since the effect is strongly dependent on the flow rate, it is recommended to keep the flow rate constant and to select only the maximum flow rate required by the process. The minimum and maximum permissible flow rate of the heat exchangers must be taken into account.

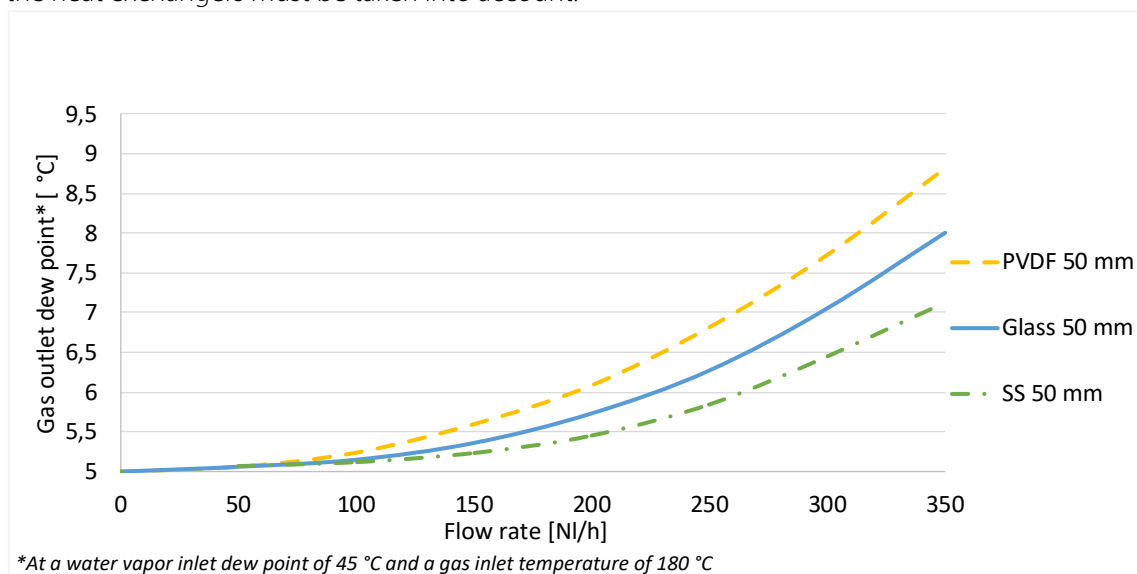



**Figure 13 Outlet dew point ECP3000C**

## 10 Operating Instructions

The display and control panel of the ECPX000C are clearly visible on the front panel of the device. In the main menu, the cooler temperature, the ambient temperature, the set absolute or differential set point and the current set point can be displayed. The set point entry and the menu for parameter setting can be accessed via a PIN entry. PIN entry prevents unintentional adjustment of the set point and the device configuration.



Use the arrow keys to navigate through the menu and enter values. Press the "OK" key  to confirm entries and the "Exit" key  to exit the input area or to reject an entry.

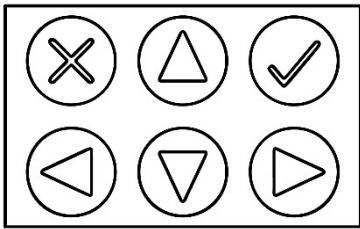

### 10.1 Menu Structure ECP1000C and ECP3000C

After approx. 3 minutes the device is ready for operation. The current cooler temperature is displayed first. Use the arrow keys to navigate through the main menu. The following figure shows an example of how you can navigate through the main menu.



Figure 14 Navigating through the ECP1000C/ECP3000C main menu



Note

Tap on the -key, to go back to the cooling temperature.

The cooling temperature is shown in the display as follows:



The cooler temperature is shown on the display.



The ambient temperature is indicated by a "°" sign on the left side of the displayed temperature.



The set point for absolute value control is indicated by an "A" and the set point for differential control by a small "d" before the temperature value. The absolute value control temperature can be set between 2 to 15 °C [35.6 to 59 °F]. The differential value control temperature can be set between dT = 2 to 15 °C [dT = 3.6 to 27 °F].



The display of the current signal value is indicated by a capital "P" on the right-hand side. The signal value is a measure for the percentage workload. The signal value can assume values from 0 to 99.



Note

**You will find the complete menu structure of the ECP1000C and the ECP3000C in the appendix of this instruction manual.**

## 10.2 Menu Structure ECP2000C

After approx. 3 minutes the device is ready for operation. The current cooler temperature of the first channel is displayed first. Use the arrow keys to navigate through the main menu. The following figure shows an example of how you can navigate through the main menu.

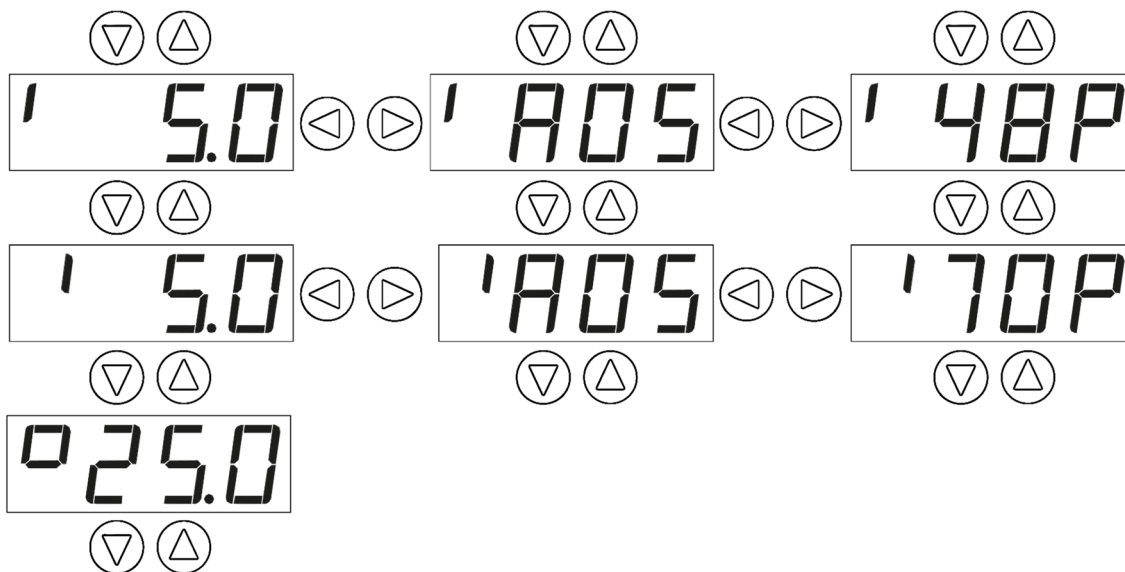
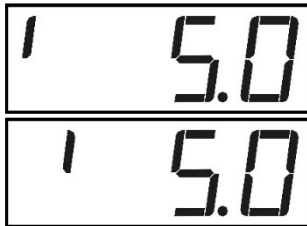

Figure 15 Navigating through the ECP2000C main menu

**Note**

Tap on the -key, to go back to the cooling temperature.

The current cooler temperatures are displayed first. The display of the ECP2000C alternates between the first and second channel every 7 seconds.



The line on the left side of the display shows which of the two cooler temperatures is currently displayed. The left line stands for channel 1, the right line for channel 2. This configuration is also found inside the unit: the first cooling stage is located on the left and the second on the right inside the cooler.



The ambient temperature is indicated by a "0" sign on the left side of the displayed temperature.

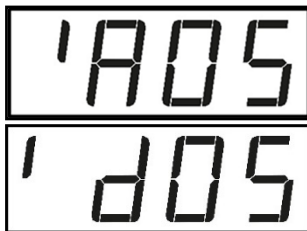

The set point for absolute value control is indicated by an "A" and the set point for differential control by a small "d" before the temperature value. The absolute value control temperature can be set from 2 to 15 °C [35.6 to 59 °F]. The differential value control temperature can be set from dT = 2 to 15 °C [dT = 3.6 to 27 °F].

Also in the set point display, the left line stands for channel 1 and the right line for channel 2.



The display of the current signal value is indicated by a large "P" on the right-hand side. The signal value is a measure for the percentage workload. The signal value can assume values from 0 to 99. The lines again show the two channels 1 and 2.

In principle, the second channel has a higher workload than the first channel. This is because the first channel receives fresh air for cooling, while the second channel cools with the already heated air from the first channel. The maximum cooling capacity specified in the data sheet takes this circumstance into account.

**Note**

**You will find the complete menu structure of the ECP2000C in the appendix of this instruction manual.**

### 10.3 PIN Entry



To enter the range of set point input or parameter setting, a PIN must be entered. The PIN "1234" is factory-set and cannot be changed.

To enter the PIN, proceed as follows:



Press and hold the -key until "0000" appears in the display.

The "0" on the left side is blinking. Use the  and -keys to enter the first digit of the PIN.

Use the  and -keys to switch to the other digits. If a digit is blinking, the PIN digit can be entered.



The PIN "1234" looks like this on the display.





Confirm the PIN with the -key.

After confirmation, immediately the display for the set point entry is shown. Press and hold the -key longer to access the parameter setting area.

The PIN is valid for 15 minutes. If you exceed this time, the display field reappears with "0000" when you press and hold the -key. The PIN must be entered there again.



#### 10.4 Set Point Entry

If you tap the -key briefly after entering the PIN, the set point for the cooler temperature appears. This set point can belong to the operating mode "absolute control" ("A") or "differential control" ("d").

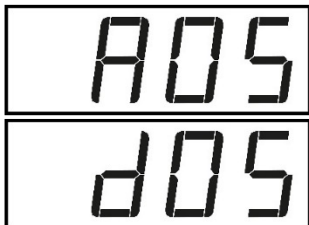
The two digits start blinking. The absolute value control temperature can be set from 2 to 15 °C [35.6 to 59 °F] using the  and -keys. The differential value control temperature can be set from dT = 2 to 15 °C [dT = 3.6 to 27 °F] using the  and -keys. The factory setting is absolute value control temperature of 5 °C [41 °C].





Use the  and -keys to switch between the operating mode and set point settings.

If the letter on the left side is blinking, you can use the  and -keys to switch between absolute and differential value control of the set point temperature.



#### Note

**Tap the -key, then the entries are discarded, and you return to the cooler temperature channel 1.**

As long as the PIN is active, the set point entry can also be accessed from the main menu. To change a set point, press the -key for 2 seconds during the current temperature or set point display. The display then changes to set point input. The two digits start blinking. Values can be set here.

With the ECP2000C you only get from the current temperature or set point display of channel 1 to the corresponding channel 1 set point input. The same applies to channel 2.

The following figure shows, using the example of an ECP1000C/ECP3000C, how to access the set point input from the main menu.



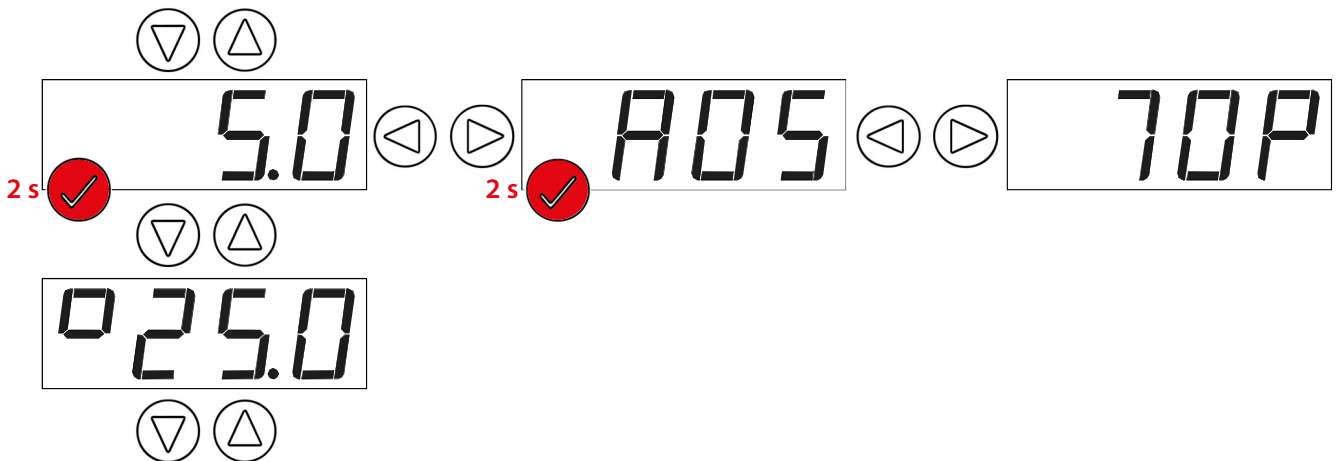





Figure 16 Reaching the set point entry from the ECP1000C/ECP3000C main menu

## 10.5 Parameter Setting

If you tap the -key after entering the PIN, the set point for the cooler temperature appears first. If the -key is pressed and held for a short moment, the display changes to code entry. Here you can enter the codes that belong to the respective parameter settings.

You can also access the parameter setting from the main menu. To do this, keep the -key pressed until the code entry is displayed. The PIN must be active in this case.







Note

**The codes for parameter settings can be found in the appendix of this instruction manual.**



To adjust the device parameters, the code belonging to the parameter must be entered and confirmed in this display. The left digit of the code entry is blinking. The first digit can be entered here.

Use the  and -keys to switch between the digits and the  and -keys to set the individual digits.

A code can have up to 3 digits. Single-digit codes are device-specific, two-digit codes are important basic settings (tens digit corresponds to the channel number), three-digit codes are used for calibration (hundreds digit: "2" stands for LA, "3" for mA calibration). The only exception is the "777" code for resetting the factory settings.

The PIN is valid for 15 minutes. If you exceed this time, the display field reappears with "0000" when you press and hold the -key. The PIN must be entered there again.

If you enter an invalid code and press the -key, the display returns to the cooler temperature of channel 1.

### 10.5.1 Setting Temperature Alarm Limits

You use the temperature alarm limits to determine when the alarm is triggered. HIGH dT and LOW dT are independently adjustable from  $dT = 2$  to  $8\text{ }^{\circ}\text{C}$  [ $dT = 3.6$  to  $14.4\text{ }^{\circ}\text{F}$ ]. In the following figure, the upper temperature alarm limit is set at  $8\text{ }^{\circ}\text{C}$  [ $46.4\text{ }^{\circ}\text{F}$ ] and the lower one at  $3\text{ }^{\circ}\text{C}$  [ $37.4\text{ }^{\circ}\text{F}$ ]. The hysteresis is set to "1".

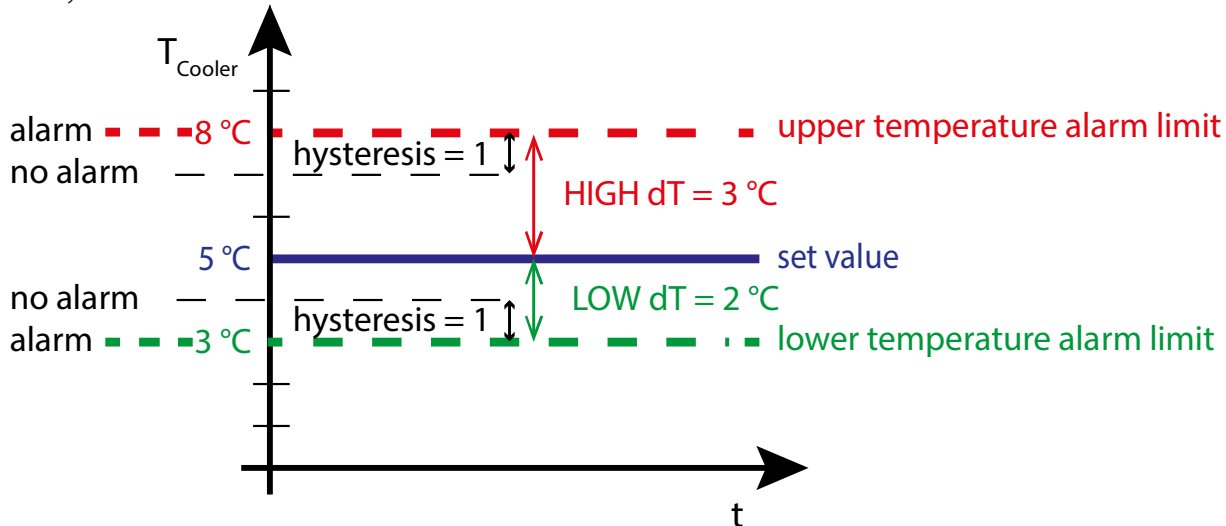
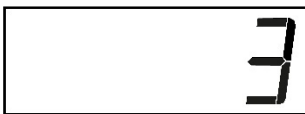

Figure 17 Temperature alarm limits and hysteresis

To set the temperature limits:



The code for setting HIGH dT of the first channel is "012", for the second channel "022". Confirm the code with the  $\checkmark$ -key, then the display of the pre-set value appears.



After confirming the code, the default value "3" appears. The value is blinking, and you can enter values from  $dT = 2$  to  $8\text{ }^{\circ}\text{C}$  [ $dT = 3.6$  to  $14.4\text{ }^{\circ}\text{F}$ ] with the  $\Delta$  and  $\nabla$ -keys.

Press  $\checkmark$  to confirm your change or  $\otimes$  to leave the code range without making any changes. After changing or aborting the display shows the cooler temperature again.

The code for LOW dT is "013" for the first channel and "023" for the second. If you enter this code, you can also change the lower temperature alarm limit.

The hysteresis setting can be changed via code "014" (channel 1) or code "024" (channel 2). The hysteresis ensures that no "fluttering" occurs in the event of a temperature alarm. The differential value  $dT = 1$  or  $2\text{ }^{\circ}\text{C}$  [ $1.8$  or  $3.6\text{ }^{\circ}\text{F}$ ] can be entered.



**If HIGH dT or LOW dT is reduced to "2", the hysteresis is automatically reduced to the differential value  $dT = 1\text{ }^{\circ}\text{C}$  [ $1.8\text{ }^{\circ}\text{F}$ ].**

## 10.5.2 Resetting to Factory Settings

With the parameter setting "777", the settings made on the device can be reset to the factory settings. Except for the calibrations performed, all set values will be reset.



**Note**

**A table with the codes reset by the "777" parameter setting can be found in the appendix of this instruction manual.**

If you hold down the -key after entering the PIN, the set point for the cooler temperature appears first. A little later the display changes to the code entry.

You can also enter the code from the main menu. To do this, keep the -key pressed until the display for code entry appears. The PIN must be active in this case.





Enter the code "777" and confirm the code with the -key.



A "0" appears on the display.

Use the  and -keys to change the value to "1".

Now you can cancel the process with the -key and exit the code entry without making any changes.

Confirm "1" with the -key, then the parameter settings are reset to the factory settings and the device will restart.

After resetting to the factory settings, the device restarts.

### 10.5.3 Brightness Setting of Display

It may be necessary to change the brightness of the display due to different lighting conditions at the locations where the cooler is used. The brightness of the display can be adjusted on the control panel of the ECPX000C.

If you press and hold the -key after entering the PIN, the set point for the cooler temperature appears first. A little later the display changes to code entry.



You can also enter the code from the main menu. To do this, keep the -key pressed until the code entry is displayed. The PIN must be active in this case.



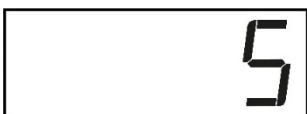

Enter the code "005" and confirm the code with the -key.



Now the default brightness value appears. The factory setting is "5".

This value is blinking and can be set between "0" and "9" with the  and  - keys. The brightness of the digits changes immediately. The lower the value, the darker the display.

Select the desired brightness value and confirm the selection with the -key or cancel the procedure with the key. Use the -key to leave the range of codes without making any changes.

After changing the brightness or canceling, the display shows the cooler temperature again.

## 11 Receipt of Goods and Storage

The **ECP 1000C/2000C/3000C** gas cooler is a complete pre-installed unit.

- Please take the ECP gas cooler and possible special accessories carefully out of the packaging material immediately after arrival and compare the goods with the items listed on the delivery note.
- Check the goods for any damage caused during delivery and, if necessary, notify your transport insurance company without delay of any damage discovered.



Note

**The equipment should be stored in a protected, frost-free room!**

## 12 Installation Instructions

The **ECPX000C** Peltier Gas Cooler is designed for wall mounting.

**The Cooler can only operate in a vertical position! The perfect functioning of the separation and drainage procedures will only be guaranteed if the equipment is used in a vertical position!**

**The cooler should be installed away from heat sources and ventilated to prevent heat accumulation.**



Note

**For outdoor installation, the cooler must be installed in a protective housing, frost-free in winter and sufficiently ventilated in summer. Avoid direct sunlight.**

**Unheated gas extraction lines must be laid with a down slope to the cooler. Condensate pre-separation is then not necessary.**

**Connect heated gas sample lines with sufficient thermal decoupling to the cooler. The insulation of the heated gas sample line must end at least 20 cm [7.9"] before the gas cooler inlet. Do not insulate the last 20 cm [7.9"] of the heated gas sample line.**

## 13 Supply Connections

### 13.1 Hose Connections

The gas inlet and outlet is located on the top of the cooler and is indicated by arrows on the Jet-Stream heat exchangers. For possible connectors see technical data (chapter 8).

Corresponding tube or flexible tubing connection fittings are optionally available through M&C.



Note

**Do not mix up the tubing connections; the inlet and outlet connections of the heat exchangers are marked with arrows;**

**After connecting all tubes and flexible tubing, the gas tightness must be checked.**

**To ensure free condensate discharge, the specified discharge cross-sections should not be reduced!**

Ensure that the connections are sealed adequately by noting the following:

#### **Duran glass heat exchangers with connections GL 18-6 respectively GL 25-12**

- Before assembly, check the GL coupling rings to see if the PTFE/silicon locking rings have been damaged.
- The sealing rings should be installed with the PTFE side facing the medium.

#### **PVDF respectively stainless steel heat exchangers with G 1/4"i respectively G 3/8" female**

- The correspondingly dimensioned tube respectively flexible tubing couplings with threaded connections have to be screwed in with PTFE thread sealing tape.

- To grant a functional and unproblematic mounting we recommend to use union pieces with taper pipe thread type R according to DIN 2999/1 in connection with suitable sealing tape.

**Note**

**When fixing the connectors in the PVDF heat exchanger hold up with a wrench at the pane of the bolt head!**

#### **Option: stainless steel heat exchanger with NPT**

- The heat exchangers with NPT threaded connectors are marked with circulated notches.
- The NPT thread must be screwed in with sealant or fixed with adhesive.

The tubes for condensate removal are connected directly to the bottom part of the heat exchangers, with the standard GL 25-12 tube connectors (Duran glass heat exchanger) respectively with the standard G 3/8" thread joint (PVDF or stainless steel heat exchanger).

Condensate removal is to be provided by the customer according to the type of operation with:

- External peristaltic pump **SR25.2-W**;
- Automatic liquid drain **AD-...** only for over-pressure operation;
- Condensate collector container which needs to be emptied manually;

**Note**

**Stainless steel heat exchangers with G 3/8" thread joint can be directly fitted up with the automatic liquid drain AD-SS by means of a thread adapter part number FF 11000 (1/2" NPT to G 3/8" female). This eliminates the need for wall mounting the AD-SS unit!**

The gas sampling tubes or condensate tube must be installed as follows:

**Note**

**The gas tightness of the connection can only be guaranteed if the connecting tube has a straight end edge (use a hose cutter)!**

- Loosen the union nut of the clamping ring fitting by turning it counterclockwise; make sure that the nut is carefully removed from the fitting body so that the clamping ring which is loose in the nut is not lost;
- Push the union nut over the connecting tube;
- Push the clamping ring with the thicker bead facing the nut onto the connecting tube;
- Attach the tubing to the support nipple of the fitting body;
- Tighten the union nut by hand.

The tubing is now mounted non-slip and pressure-resistant.

## 13.2 Electrical Connections



Warning



**Electric shock risk!**

**If a fault occurs, the housing is connected to the power supply!**

**Follow the connection sequence:**

**Connect the mains plug to the mains voltage first, then the alarm relay plug.**

**Wrong voltage can destroy the cooler.**

**When connecting the equipment, please ensure that the supply voltage is identical with the information provided on the model type plate.**



Warning

**Attention must be paid to the requirements of IEC 364 (DIN VDE 0100) when setting high-power electrical units with nominal voltages of up to 1000 V, together with the associated standards and stipulations.**

**A main switch must be provided externally.**

**The supply circuit of the device is provided with a fuse corresponding to the rated current (overcurrent protection); the electrical data can be found in the technical data.**

### 13.2.1 Power Supply Connection

The power connection is pluggable and uses a type A solenoid valve plug. The mains plug grounds the device. Always connect the mains plug first.

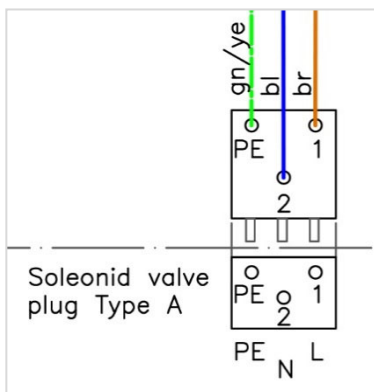

Figure 18 Circuit diagram detail: power supply connection



Note

**The circuit diagram with the assignment of the mains plug can be found in the appendix of this instruction manual.**

### 13.2.2 Alarm Relais Connection



Warning



**Electric shock risk!**

**If a fault occurs, the housing is connected to the power supply!**

**Follow the connection sequence:**

**Connect the mains plug to the mains voltage first, then the alarm relay plug.**

The alarm relay connection is pluggable and uses a type C solenoid valve plug. The switching capacity of the 2 changeover contacts is at 250 V, 2 A, 500 VA, 50 W. The length of the connecting cable is not restricted.

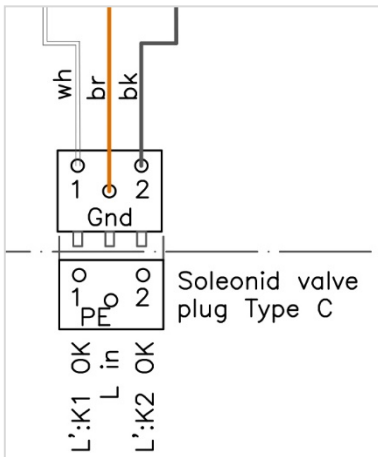

Figure 19 Circuit diagram detail: alarm relay connection



Note

**Note: Inductive DC loads (e.g. relays, solenoid valves) may only be connected via flyback diodes.**



Note

**The circuit diagram with the assignment of the alarm plug can be found in the appendix of this instruction manual.**

### 13.2.3 mA Output Connection for Cooler Block Temperature(s) (Optional)

The mA connection for the temperatures of the one to two cooling blocks (depending on the device) is pluggable and uses a Phoenix circular connector.



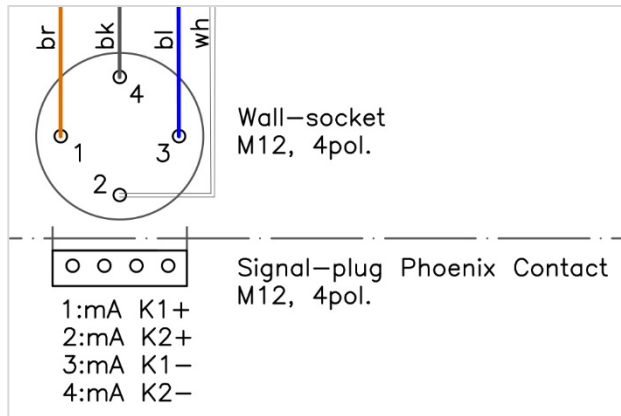

**Figure 20** Circuit diagram detail: mA output connection for cooler block temperature(s)

The mA outputs of the cooling block temperatures are potential-free and the max. burden is 500 Ohm. The length of the connecting cable is not restricted.

The current output limits in the case of 4 - 20 mA in the lower range to 3.8 mA and in the upper range to 20.5 mA. In the case of 0 - 20 mA, it limits the upper range to 20.5 mA.



Note

**If one or two mA outputs are ordered when ordering the instrument, the mA output is calibrated at the factory.**

**The mA output is set to 4 - 20 mA as standard, but can be changed to 0 - 20 mA on the instrument. In both cases the mA range corresponds to the temperature range -10 to +50 °C [14 to 122 °F].**



Note

**If a calibration error occurs and the mA output has been calibrated, the limiting values also change!**



Note

**The circuit diagram with the assignment of the mA plug can be found in the appendix of this instruction manual.**

In chapter 23.4 "Calculations for mA Output" you will find the calculation of the temperature based on the mA value, the calculation of the mA value based on the temperature and the step size and resolution of the mA output.

### 13.2.4 mA Connection Thermocouple (Optional, ECP1000C Only)

If it is technically necessary to measure the output temperature in the gas, the thermocouple option can be purchased. This option is only available for the ECP1000C and includes:

- A special glass heat exchanger (with an additional gas screw connection for the thermocouple)
- One thermocouple type K class 1 shielded
- A built-in thermocouple transmitter with a mA range of 4 - 20 mA (corresponds to -10 to 50 °C [14 to 122 °F], not changeable)
- mA plug and socket

The mA output for the thermocouple is not electrically isolated. The cable length is not limited. The maximum load is 180 Ohm. The measurement accuracy is as follows:

- $\pm 0.5\text{ }^{\circ}\text{C}$  [ $\pm 0.9\text{ }^{\circ}\text{F}$ ] Measuring accuracy of the transmitter
- $\pm 1\text{ }^{\circ}\text{C}$  [ $\pm 1.8\text{ }^{\circ}\text{F}$ ] Reference junctions' temperature accuracy
- $\pm 1.5\text{ }^{\circ}\text{C}$  [ $\pm 2.7\text{ }^{\circ}\text{F}$ ] Limiting deviation for thermocouple type K class 1



Note

**The assignment of the mA connector can be found in the "Wiring diagram: optional thermocouple (ECP1000C)" in the appendix of this instruction manual.**

### 13.2.5 LA Connection (Optional, Type LA1 or LA1S)

External liquid alarm sensors type LA1 (without cable break detection) or LA1S (with cable break detection) can be connected to monitor the ECPX000C to protect the downstream analyzers. The liquid alarm sensors type LA1 or LA1S detect a condensate ingress in case of a possible defect or overload of the cooler.

The ECPX000C detects the channel-dependent alarm, reports it on the display and switches the corresponding alarm relay. The alarm relay can be used to interrupt the gas supply, either by switching off the sample gas pump or by controlling a shut-off solenoid valve.



Note

**The M&C liquid alarm sensors type LA1 and LA1S operate on the principle of electrical conductivity from a conductance of  $50\text{ }\mu\text{S/cm}$ .**

The optional sensor type LA1S with cable breakage detection is offered as standard for the ECPX000C. If no liquid alarm sensor is purchased with the device, the evaluation is deactivated. This can be subsequently activated by the customer if required.

The LA connection is located inside the device on the circuit board. When connecting external liquid alarm sensors type LA1 or LA1S, the connection cable must not exceed 3 m [ $\approx 9.8\text{ ft}$ ] in length.

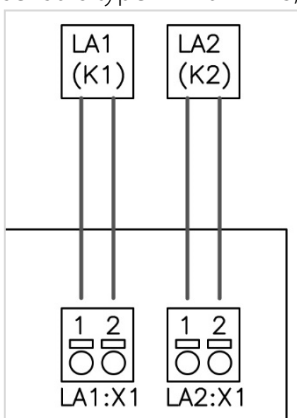

**Figure 21** Circuit diagram detail: LA connection

**Note**

**The LA evaluation has no hold function. This means that the cooler cancels the alarm as soon as the LA sensor has dried, and the alarm cancellation limit is undershot again.**

**Note**

**The circuit diagram with the assignment of the LA connection can be found in the appendix of this instruction manual.**

## 14 Start-up

For start-up, the mains plug must be connected first. The mains plug connects the device to ground.

If the cooler is switched on after a slightly longer period of use on site, it displays the current heat sink temperature. The cooler immediately starts to cool down to the standard set absolute temperature of 5 °C [41 °F].

The display of the ECP1000C and ECP3000C switches between the current cooler temperature and the temperature alarm display A1 until the pre-set alarm cancellation limit of 6 °C [42.8 °F] is undershot. With the ECP2000C, the display switches between the current cooler temperatures and the temperature alarm displays A1 and A2 of the respective channel.

After about 3 minutes the cooler drops below the alarm cancellation limit of 6 °C [42.8 °F]. The cooler now regulates the 5 °C [41 °F] and the alarm disappears. The alarm relay is switched according to the alarm, the alarm is triggered, and the relay is energised. The 3 minutes assume that the cooler is still unloaded. If there is gas in the cooler, the time increases depending on the energy content of the gas.

### 14.1 Parameter Setting during Commissioning

Immediately after starting the device, the pre-set parameters can be changed. The important basic settings are:

- **Set temperature:** 5 °C (adjustable from 2 to 15 °C) [41 °F (adjustable from 35.6 to 59 °F)]
- **Temperature control modi:** absolute temperature set point (A) or differential temperature set point (d)
  - **Absolute temperature set point (A):** The cooler cools to the set temperature regardless of the ambient temperature.
  - **Differential temperature set point (d):** The cooler temperature usually corresponds to the ambient temperature currently measured by the device minus the set point temperature. To protect the cooler from freezing, the cooler temperature is limited to 2 °C [35.6 °F] at low ambient temperatures, regardless of the adjusted set point.
- **Temperature alarm limits:**  $\pm 3$  °C [ $\pm 5.4$  °F] from set point temperature (HIGH dT and LOW dT are independently adjustable from dT = 2 to 8 °C [dT = 3.6 to 14.4 °F]).

- **Hysteresis:** differential value 2 °C [3.6 °F] (differential value can be set to 1 or 2 °C [1.8 or 3.6 °F])  
As soon as one or both temperature alarm limits are reduced to 2, the hysteresis is automatically reduced to 1.

In addition, when commissioning a purchased mA output or LA sensor, it should be checked whether they are correctly preconfigured for the planned process.

## 15 Closing Down



**Warning**

**Electric shock risk!**

**If a fault occurs, the housing is connected to the power supply!**



**Follow the disconnection sequence:**

**Disconnect the alarm relay plug from the mains voltage first, then the mains plug.**



**Note**

**The area in which the cooler is situated, when not in use, must be kept free of frost at all times!**

No special measures need to be taken if the cooler is shut down for a short period of time.

If the cooler is to be shut down for a longer period of time, we recommend flushing it with inert gas or air. Residual condensate should be completely removed from the cooler.



**Warning**

**Aggressive condensate is possible.**



**Wear protective glasses and proper protective clothing!**

## 16 Maintenance

Before starting any maintenance work, follow all safety notes and descriptions stated in this instruction manual. Before the maintenance work is carried out, it is necessary to follow the specific safety procedures in regard to the system and operational process!



**Warning**



**High voltage.**

**Disconnect the mains plug before opening the cooler housing!**

**Electric shock risk when opening the cooler housing!**

**If a fault occurs, the housing is connected to the power supply!**

**Follow the disconnection sequence:**

**Disconnect the alarm relay plug from the mains voltage first, then the mains plug.**

The ECPX000C gas cooler requires no particular routine maintenance. Depending on the quality of the ambient air the cooling fin block should be blown out with compressed air from time to time.

### 16.1 Replacing a Heat Exchanger

Removal of the heat exchangers may be necessary to carry out maintenance or repair work. The following step-by-step procedure is recommended when removing a heat exchanger:

- Release the upper gas connections and lower condensate connections.



**Warning**



**Aggressive condensate is possible.**



**Wear protective glasses and proper protective clothing!**

- Pull the heat exchanger upwards from the cooling block by turning it slightly;

The installation is as follows:

- Dry and clean the opening in the aluminium cooling block with a cloth;
- Apply a thin coat of heat sink compound (item no. 90K0115) to the insertion opening, covering the entire surface;
- Apply a thin, even coat of heat sink compound to the entire surface of the heat exchanger to ensure a good cold transition. To prevent the heat sink compound from penetrating into the heat exchanger during installation, it is advisable to seal the condensate drain with an adhesive tape beforehand;

- Insert the heat exchanger into the insert opening of the cooling block by turning it slightly and pushing it up to the top stop;
- Remove adhesive tape and pressed out heat sink compound;
- Connect the tubing.

**Note**

**Do not mix up the tubing connections; the inlet and outlet connections of the heat exchangers are marked with arrows.**

When installing heat exchangers of type ECP 1000C/2000C/3000C made of Duran glass, note the following:

- Check PTFE/silicone clamping rings for damage. The clamping rings must be mounted with the PTFE surface pointing to the medium side, otherwise the necessary gas tightness cannot be guaranteed.
- Hand tighten the GL union nuts by turning them clockwise;

## 16.2 Information on maintenance of the optionally installed peristaltic pump(s)

The instruction manual for the peristaltic pump type SR25.2-W contains all necessary information for qualified personnel to maintain the peristaltic pump.

Please read these instructions carefully before carrying out any maintenance work.

If you have any questions about the peristaltic pump or maintenance, please contact M&C or your authorized M&C dealer.

**Note**

**Information for the qualified personnel on maintenance of the peristaltic pump can be found in the SR25 instruction manual (included in the scope of delivery of the peristaltic pump).**

**The SR25 instruction manual is also available on our website [www.mc-techgroup.com](http://www.mc-techgroup.com).**

## 17 Alarm and Error Messages

The ECPX000C has several monitoring functions. If an alarm limit is exceeded or not reached or if an error occurs during operation, the corresponding messages are shown on the display. These messages are displayed cyclically and alternate with the current cooler temperatures.

If several alarm or error messages occur simultaneously, the messages are shown on the display one after the other.

The alarm and error messages are listed here:



Display	Description	Action	Clear the alarm/error message
<b>A1</b>	The temperature of stage 1 has exceeded the outer limit of the alarm band	Relay 1 opens	The temperature of stage 1 exceeds the inner limit of the alarm band
<b>A2</b>	The temperature of stage 2 has exceeded the outer limit of the alarm band	Relay 2 opens	The temperature of stage 2 exceeds the inner limit of the alarm band
<b>LA1</b>	The liquid alarm sensor LA1 (channel 1) has registered a level of humidity corresponding to the set sensitivity	Relay 1 opens	The LA1 (channel 1) must register a dry state 15 % below the trip limit.
<b>LA2</b>	The liquid alarm sensor LA2 (channel 2) has registered a level of humidity corresponding to the set sensitivity	Relay 2 opens	The LA2 (channel 2) must register a dry state 15 % below the trip limit.
<b>E1</b>	The temperature sensor 1 cannot be queried or does not pass the plausibility check several times	Relay 1 opens, Control of the Peltier element is switched off	The measured values can be read again (e.g. after cable examination or sensor replacement)
<b>E2</b>	The temperature sensor 2 cannot be queried or does not pass the plausibility check several times	Relay 2 opens, Control of the Peltier element is switched off	The measured values can be read again (e.g. after cable examination or sensor replacement)
<b>E3</b>	The temperature sensor 3 cannot be queried or does not pass the plausibility check several times	No effect with absolute value control. With dT control, the corresponding relay opens, and the stage is switched off.	The measured values can be read again (e.g. after cable examination or sensor replacement)
<b>E4</b>	No voltage flanks resulting from a fan rotation are measured	Stage 1 and stage 2 switch off and both relays drop out.	The fan supplies voltage flanks again (e.g. after cable examination or fan replacement)
<b>E5</b>	The temperature of cooling stage 1 exceeds a maximum value of 60 °C [140 °F]	Relay 1 opens, Control of the Peltier element is switched off	Device restart after cooling down
<b>E6</b>	The temperature of cooling stage 2 exceeds a maximum value of 60 °C [140 °F]	Relay 2 opens, Control of the Peltier element is switched off	Device restart after cooling down

## 18 mA Output

The mA outputs built-in by M&C are factory calibrated and set to the range "4-20 mA". Later purchased mA outputs must be calibrated. To set the range and calibration, first enter the PIN:



Press and hold the -key until "0000" appears in the display.

The "0" on the left side is blinking. Use the  and -keys to enter the first digit of the PIN.



Use the  and -keys to switch to the other digits. When a digit is blinking, enter the PIN digit.



The PIN "1234" looks like this on the display.

Confirm the PIN with the -key.



If you tap the -key after entering the PIN, the set point for the cooler temperature appears first. If the -key is pressed and held for a short moment, the display changes to code entry. The right digit of the code entry is blinking. Here you can enter the codes that belong to the respective parameter settings.

You can also access the parameter setting from the main menu. To do this, keep the -key pressed until the code entry is displayed. The PIN must be active in this case.

### 18.1 mA Output Range Selection

The optional mA output can be changed from 4-20 mA to 0-20 mA. To select the mA range, proceed as follows:





Enter the code "015" for the first channel and "025" for the second channel.

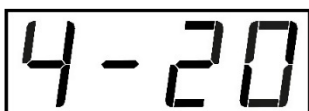

Confirm the code with the -key, then the display of the preset range appears.



The default value "4-20", which stands for 4 to 20 mA, appears on the display.

The whole display is blinking here. Use the  and -keys to switch between "4-20" and "0-20".



Press  to confirm your change or  to leave the code range without making any changes. After changing or aborting the display shows the cooler temperature again.





Note

The basic calculations of the mA output are listed in the appendix of this instruction manual.

## 18.2 Calibrating a mA Output

The mA outputs built-in by M&C are factory calibrated. If required, the basic accuracy of the mA outputs can be optimized by recalibration.

A later installed mA output must be calibrated. The mA output is suitable for a maximum load of 500  $\Omega$  only. During calibration, first the lower and then the upper value of the mA output will be calibrated.



Note

**If one or two mA outputs are ordered when ordering the instrument, the mA output is calibrated at the factory. If a mA output is purchased by the customer and retrofitted by the customer, the calibration must be carried out by the customer. Optionally, the device can be sent to M&C for retrofitting.**

**The mA output is set to 4 - 20 mA as standard, but can be changed to 0 - 20 mA on the instrument. In both cases the mA range corresponds to the temperature range -10 to +50 °C [14 to 122 °F].**

### Current limitation:

The current output limits in the case of 4 - 20 mA in the lower range to 3.8 mA and in the upper range to 20.5 mA. In the case of 0 - 20 mA, it limits the upper range to 20.5 mA.



Note

**If a calibration error occurs and the mA output has been calibrated, the limiting values also change!**

To calibrate an mA output, proceed as follows:

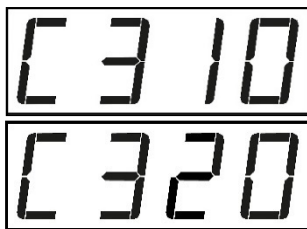

Enter the code "310" for the calibration of the lower value of the mA output (channel 1). To calibrate the lower limit of the second channel of the ECP2000C, enter the code "320".

Now connect a current meter to the connector of the mA output. This current meter should measure a value close to 1 mA. You can now adjust this value in 0.0054 mA steps with the up and down arrow keys. After the adjustment, the current meter should display 1 mA as accurately as possible.

Accept the value with the -key.

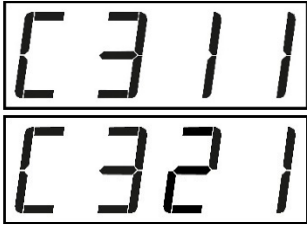

Enter the code "C311" for the calibration of the upper value of the mA output (channel 1). To calibrate the upper limit of the second channel of the ECP2000C, enter the code "C321".

Now connect a current meter to the connector of the mA output. This current meter should be used to measure a value close to 20 mA. You can now adjust this value in 0.0054 mA steps with the up and down arrow keys until the current meter displays 20 mA as accurately as possible. Accept the value with the -key.

The cooler should then be in a steady state at 5 °C [41 °F] (absolute value control) and provide one of the following values:

- 8 mA (in case of 4 - 20 mA)
- 5 mA (in case of 0 - 20 mA)



The cable length is not limited and the cable does not need to be shielded.

## 19 Liquid Alarm Sensor (LA) type LA1 and LA1S

The liquid alarm sensors LA1 or LA1S installed by M&C are factory calibrated to tap water and activated. Later purchased liquid alarm sensors must be activated and calibrated. To do this, first enter the PIN:



Press and hold the -key until "0000" appears in the display.

The "0" on the left side is blinking. Use the  and -keys to enter the first digit of the PIN.



Use the  and -keys to switch to the other digits. When a digit is blinking, enter the PIN digit.



The PIN "1234" looks like this on the display.

Confirm the PIN with the -key.



If you tap the -key after entering the PIN, the set point for the cooler temperature appears first. If the -key is pressed and held for a short moment, the display changes to code entry. The right digit of the code entry is blinking. Here you can enter the codes that belong to the respective parameter settings.

You can also access the parameter setting from the main menu. To do this, keep the -key pressed until the code entry is displayed. The PIN must be active in this case.

### 19.1 Activating the LA

A retrofit liquid alarm sensor must be activated.

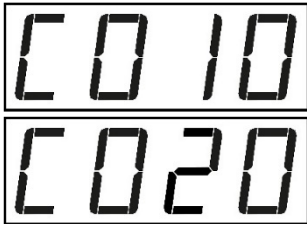

The code for activation is "010" for an ECP1000C or ECP3000C. To activate both channels of the ECP2000C, enter "010" for the first channel and "020" for the second channel.

Confirm the code with the -key.

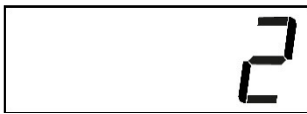

You can choose between the values "0", "1" and "2". With "1" you activate the sensor without cable break detection, with "2" you activate the sensor with cable break detection. With "0" the sensor is deactivated accordingly.

After activating the LA1S, the sensor needs to be calibrated.

### 19.2 LA Sensitivity adjustment

The sensitivity can be changed by following these steps:

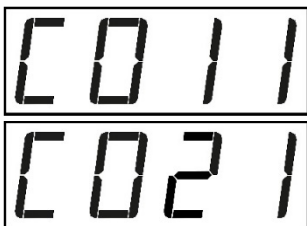

Enter the code "011" to change the sensitivity of the liquid sensor (channel 1). With code "021" you can change the sensitivity of the second channel of the ECP2000C.

The default value is 2 and can be changed from 1 to 7. The sensitivity corresponds to the switching threshold for the alarm and is to be understood as follows:

Sensor state	Sensitivity	Electrical conductivity
Dry	0 %	
7	30 %	~50 µS/cm
6	40 %	
5	50 %	
4	60 %	
3	70 %	
2	80 % (Standard)	~300 µS/cm
1	90 %	
Wet	100 %	

The cancellation limit is always 15 % below the sensitivity limit. If the sensitivity value of 2 is not changed, the alarm is triggered at 80 % and is automatically cancelled as soon as it falls below 65 %.

The following diagram illustrates the correlations:

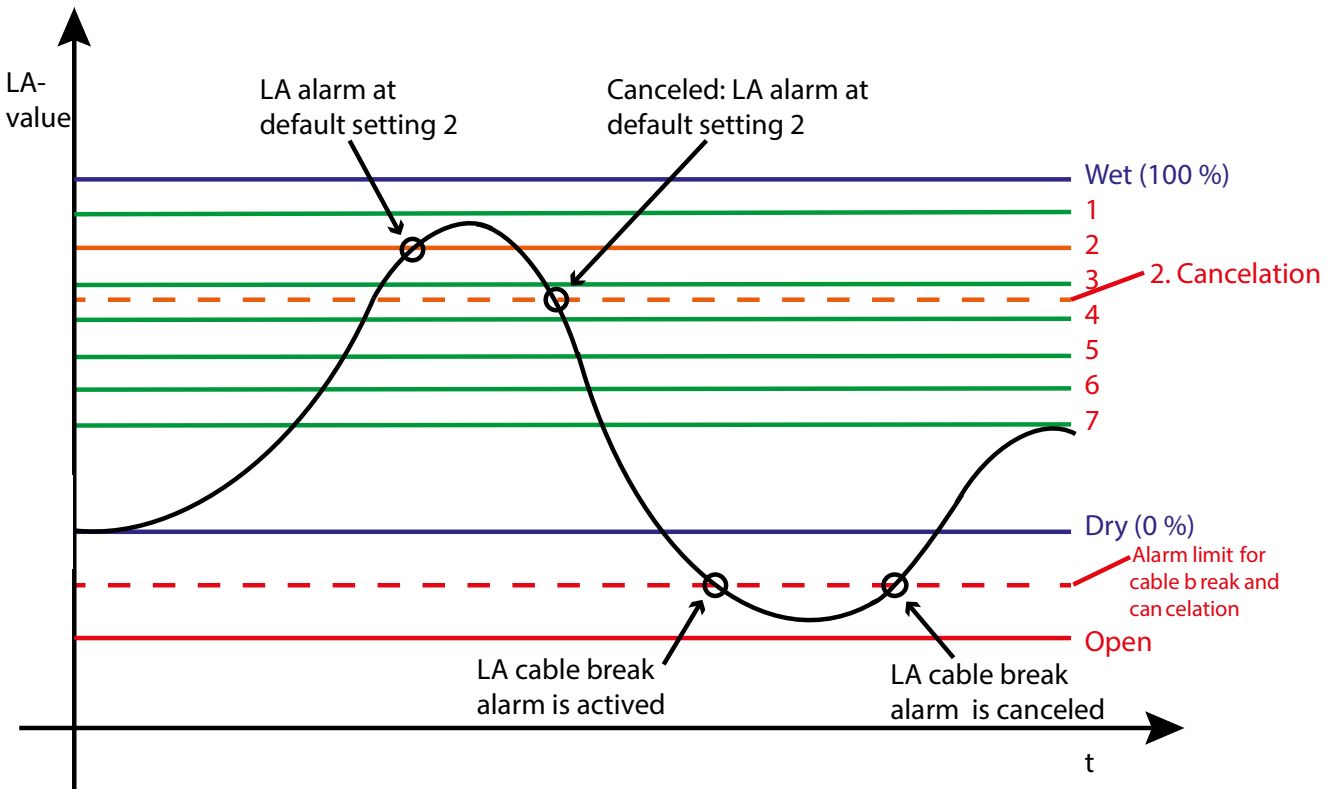

Figure 22 LA alarm limits

### 19.3 LA Calibration

The liquid alarm sensors type LA1 or LA1S installed by M&C are factory activated and calibrated. If required, the basic accuracy of the liquid alarm sensors can be optimized by recalibration. Later-installed liquid sensors must be activated and calibrated.



Note

**Make sure that the LA is activated. If a retrofitted LA is not activated, the calibration has no effect and will be discarded.**

To calibrate a liquid alarm sensor, proceed as follows:



First calibrate the "dry state" of the liquid alarm sensor. To do this, leave the LA in the dry state and enter the code "210" (for channel 1) or "220" (for channel 2). Confirm the displayed value with the -key.



Then calibrate the "wet state" of the liquid alarm sensor. Immerse the LA in the process-dependent condensate to calibrate the 100 % wet condition via code "211" (for channel 1) or "221" (for channel 2). Confirm the displayed value with the -key.

## 20 Retrofitting: Peristaltic Pump SR25.2-W



Note

For installation instructions and supply connections please refer to the SR25 instruction manual (included in the peristaltic pump delivery). The SR25 instruction manual is also available on our website [www.mc-techgroup.com](http://www.mc-techgroup.com).

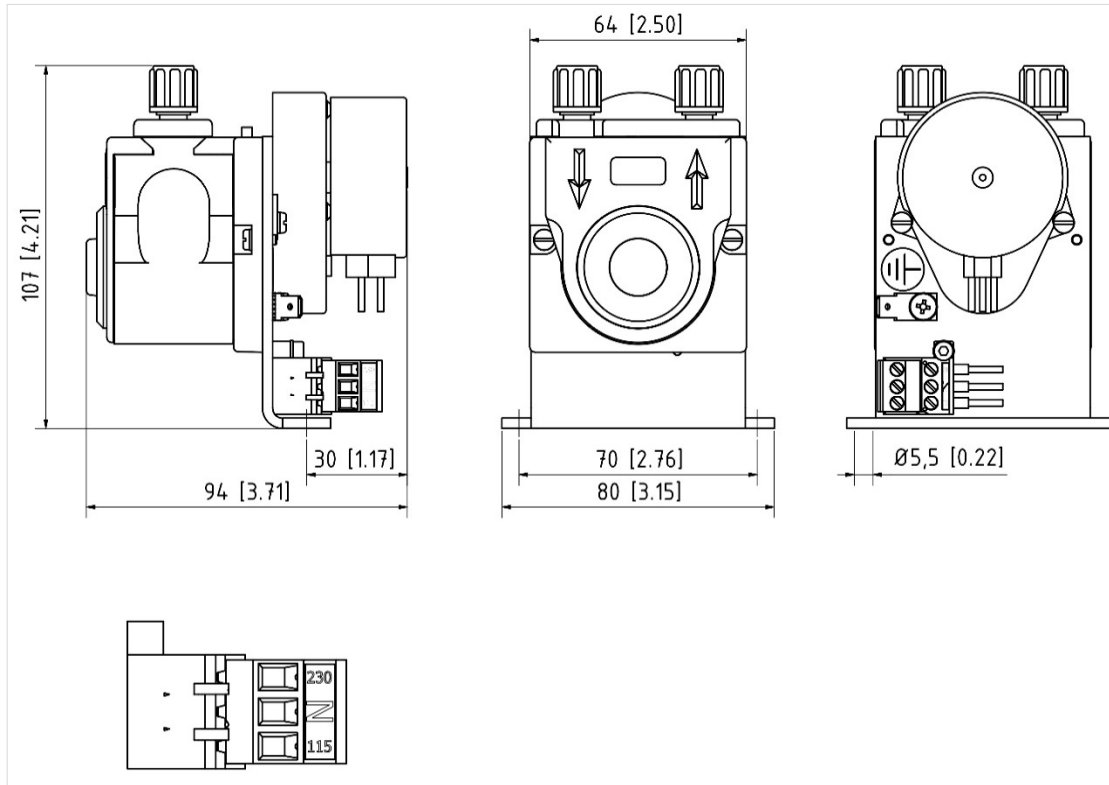

Metric dimensions are rounded. Inch dimensions are for reference only. In case of doubt or conflict metric units take priority.

**Figure 23** Dimensions SR25.2-W

## 21 Proper disposal of the device

At the end of the service life of our products, it is important to take care of the appropriate disposal of obsolete electrical and non-electrical devices. To help protect our environment, follow the rules and regulations of your country regarding recycling and waste management.

## 22 Spare Parts and Options list

The replacement intervals for consumables (C), recommended spare parts (R) and spare parts (S) depend on your operating conditions and the specific operating condition of the equipment.

The following table gives recommendations on the stocking of consumables (parts with an expected service life) and recommended spare parts (to ensure a high availability of the unit).

The quantities indicated for these parts for operation in years are based on empirical values.

For spare parts (S), spare parts/options (S/O) and options (O) no recommended quantities can be given for operation in years.

(C) Consumables, (R) Recommended spare parts, (S) Spare parts, (O) Options

Part-No.:	Description:	C/R/S/O:	Recommended amount based on number of years of operation [years]		
			1	2	3
90K7200	Electronics for ECP1000C and ECP3000C	S	-	-	-
90K7200	Electronics for ECP2000C	S	-	-	-
90K7220	mA-electronics	S	-	-	-
EZ0034	Power supply for ECP1000C and ECP3000C	S	-	-	-
EZ0035	Power supply for ECP2000C	S	-	-	-
93K0012	Fan	S	-	-	-
93K2080	Peltier element	S	-	-	-
93K2070	Temperature sensor	S	-	-	-
01K9200	1 x mA- output incl. plug and socket, mounting and calibration (per channel)	O	-	-	-
01K9250	1 x Thermocouple incl. plug, socket and signal converter, and mounting incl. special heat exchanger with three gas connections (ECP1000C only)	S/O	-	-	-
01K9260	Type LA1S: Liquid alarm sensor with cable break detection <i>Note: Evaluation is carried out as standard in the ECPX000C, LA1S for M&amp;C universal filters with D connection</i>	S/O	-	-	-
01K9270	Type LA1: Liquid alarm sensor without cable break detection <i>Note: Evaluation is carried out as standard in the ECPX000C, LA1 for M&amp;C universal filters with D connection</i>	S/O			
97K0100	Heat exchanger Ø 25 mm glass	R/O	1	1	1
97K0115	Heat exchanger Ø 25 mm stainless steel	R/O	1	1	1
97K0110	Heat exchanger Ø 25 mm PVDF	R/O	1	1	1
93K0103	Heat exchanger Ø 25 mm with 3 connections, one for thermocouple, glass <u>only</u>	R/O	1	1	1
93K0140	Heat exchanger Ø 50 mm glass	R/O	1	1	1
93K0160	Heat exchanger Ø 50 mm stainless steel	R/O	1	1	1

Part-No.:	Description:	C/R/S/O:	Recommended amount based on number of years of operation [years]		
			1	2	3
93K0170	Heat exchanger Ø 50 mm PVDF	R/O	1	1	1
90K0115	Heat sink compound für heat exchanger (50 g)	R	1	1	1
90K0116	Heat sink compound silver	S	-	-	-
01P1307	Peristaltic pump SR25.2-W, 0,3 NI/h, 115 / 230 V AC with PVDF tube connection fitting DN4/6 mm	S	-	-	-
90P1020	SR25.2: Driver, complete	R	-	1	2
90P1050	SR25.2: Conveying belt	R	-	1	2
90P1007	SR25 pump tubing with PVDF tubing connection DN4/6mm	C	2	4	8
01P9160X	SR25.2-W Connection set without peristaltic pump (PVDF screw connections for SS, PVDF and Glass HE, 0.5 m Novoprene hose and fixing screws)	O			

## 23 Appendix



For additional manuals and data sheets please look on our home page

[www.mc-techgroup.com](http://www.mc-techgroup.com)

Instruction manual peristaltic pump **SR 25.2**

Data sheet for Condensate vessel **TG, TK**

Data sheet for **GL**-connectors

Data sheet for Automatic liquid drain **AD-SS**

Data sheet for Automatic liquid drain **AD-P**

23.1 Main Menu: ECP1000C and ECP3000C

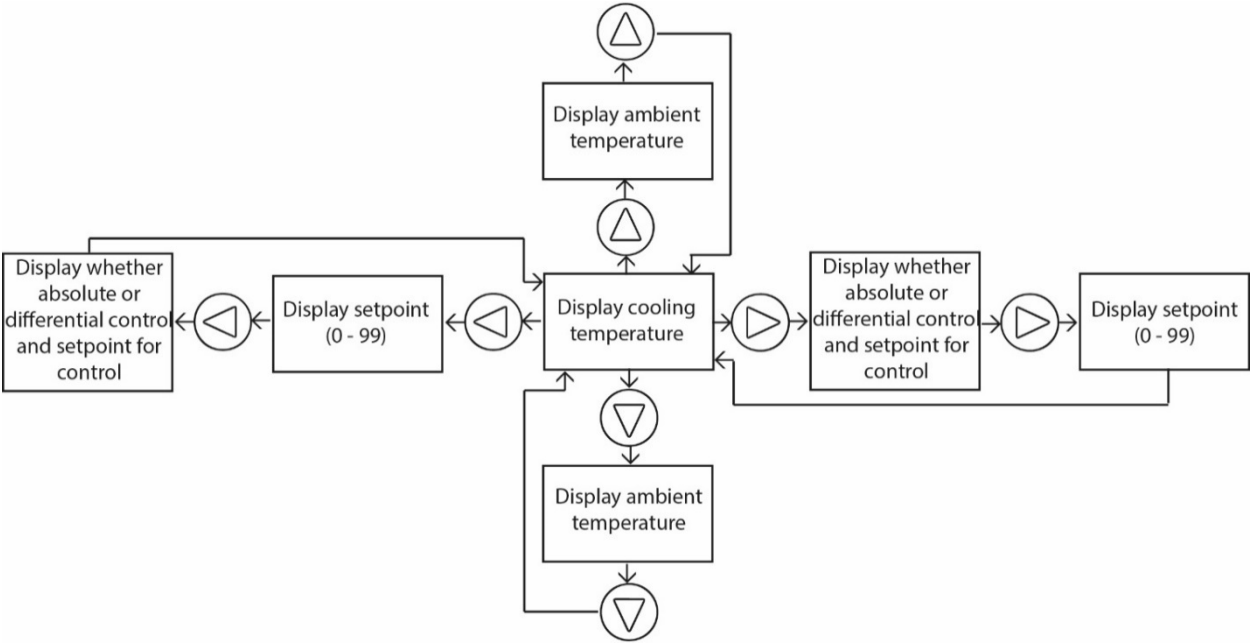

Figure 24 Menu structure of a one channel cooler

23.2 Main Menu: ECP2000C

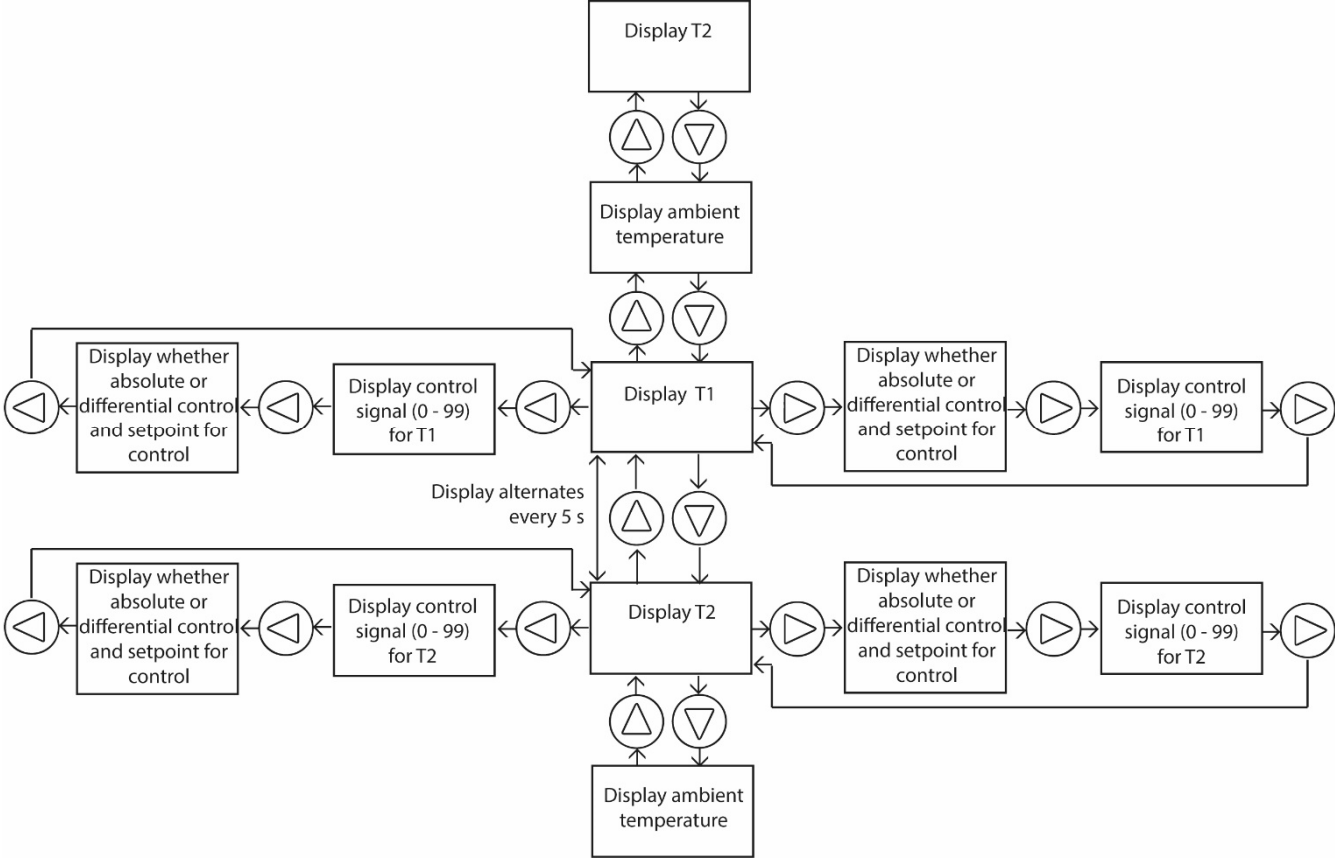

Figure 25 Menu structure of the ECP2000C



### 23.3 Menu Structure after Entering the PIN

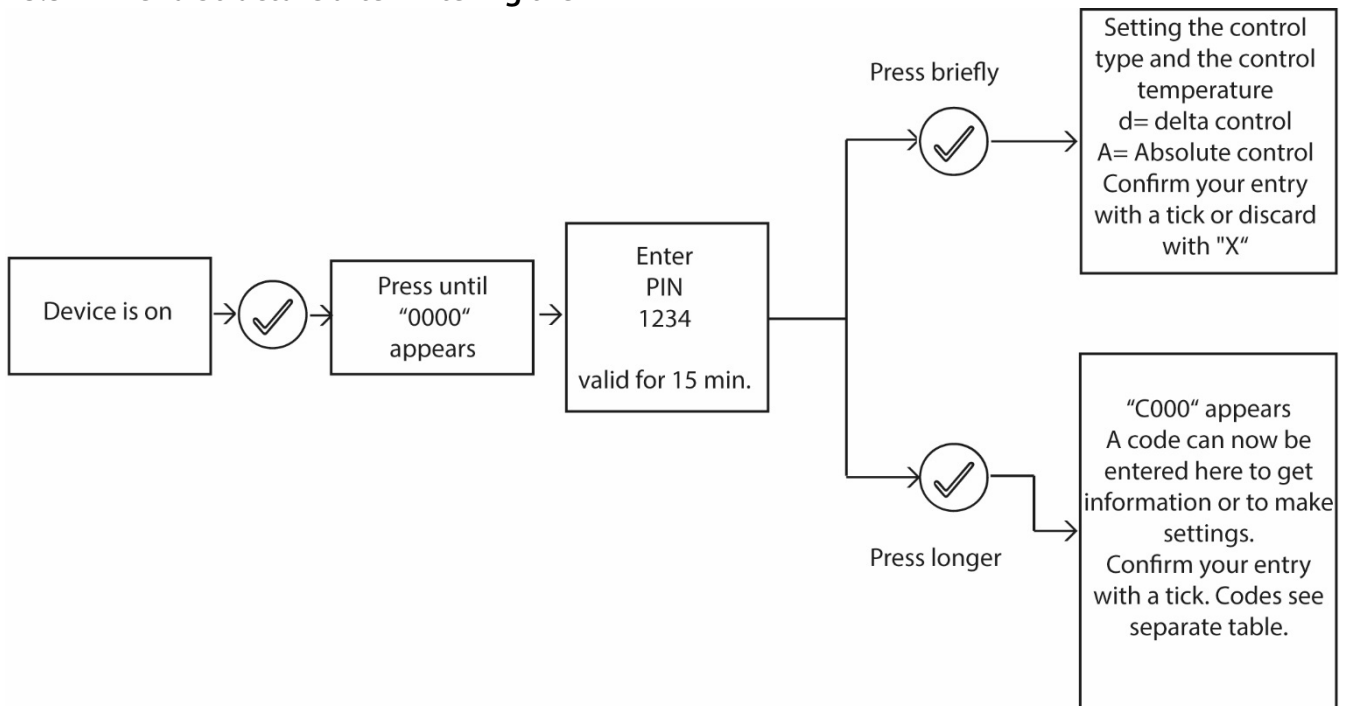

Figure 26 Menu structure after entering the PIN

### 23.4 Calculations for mA Output

The mA output value always corresponds to the current cooler temperature.



Note

**The calculations do not apply to the thermocouple option (ECP1000C only).  
For more information see chapter 13.2.4 "mA Connection Thermocouple (Optional, ECP1000C Only)".**

#### 23.4.1 Calculating the mA Value Based on the Temperature

The value of the mA output signal can be calculated from the displayed cooler temperature. The following formulas are available for calculation:

$$I_{measured}[mA] = \left( \frac{(T_{display}[^{\circ}C] + 10) * 4}{15} \right) + 4 \quad \text{if } 4 - 20 \text{ mA is set}$$

$$I_{measured}[mA] = \left( \frac{(T_{display}[^{\circ}C] + 10)}{3} \right) \quad \text{if } 0 - 20 \text{ mA is set}$$

### 23.4.2 Calculating the Temperature Based on the mA Value

The cooler temperature can be calculated from the measured mA output signal. The following formulas are available for calculation:

$$T[{}^{\circ}\text{C}] = \left( \frac{(I_{\text{measured}}[\text{mA}] - 4) * 15}{4} \right) - 10 \quad \text{if } 4 - 20 \text{ mA is set}$$

$$T[{}^{\circ}\text{C}] = I_{\text{measured}}[\text{mA}] * 3 - 10 \quad \text{if } 0 - 20 \text{ mA is set}$$

### 23.4.3 Step Size and Resolution of the mA Output

The mA outputs have a resolution of 0.1 °C [0.18 °F].

- 4 - 20 mA: 0.1 °C [0.18 °F] corresponds to 0.027 mA
- 0 - 20 mA: 0.1 °C [0.18 °F] corresponds to 0.033 mA

### 23.5 Circuit Diagram

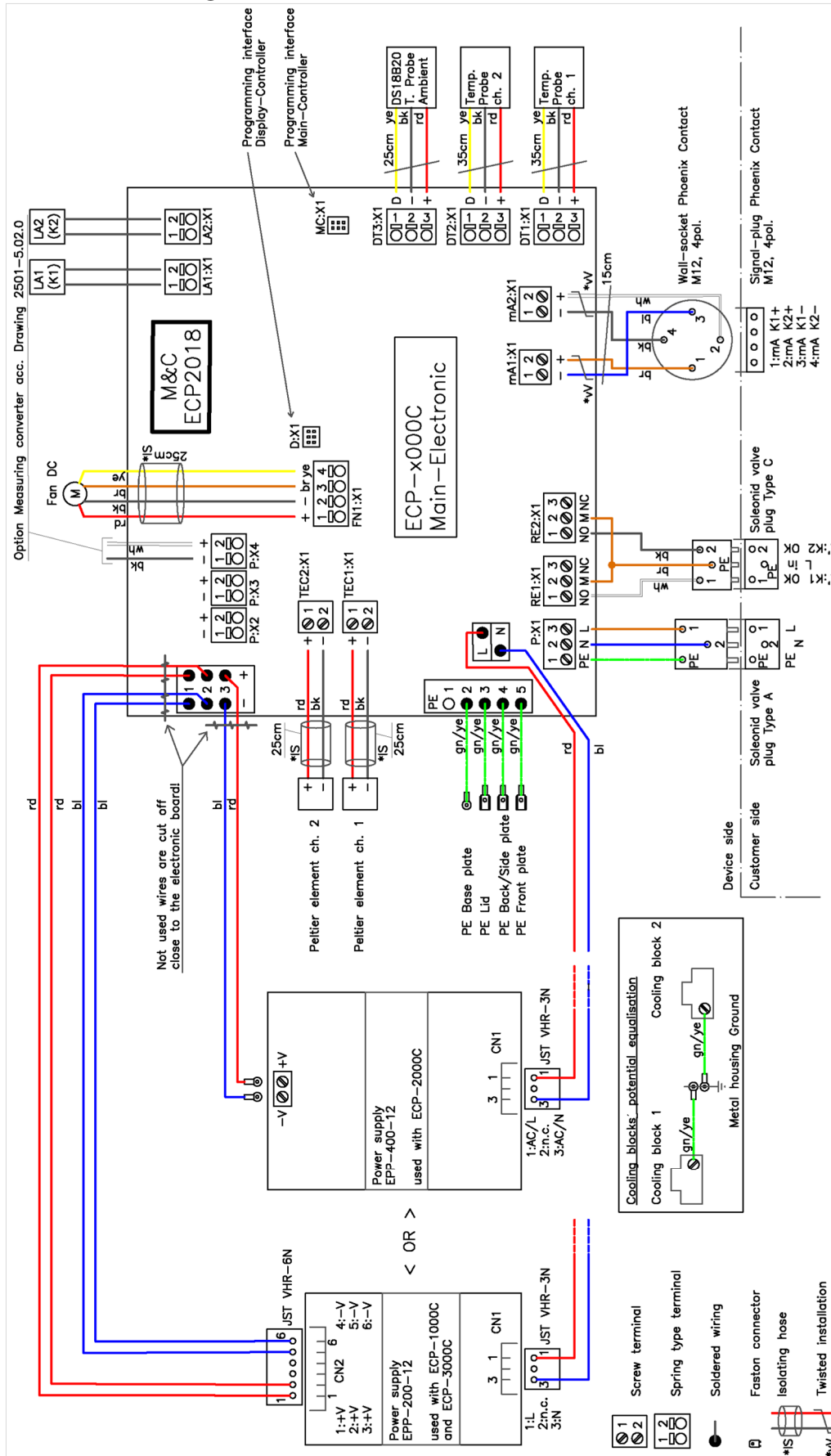

Figure 27 Circuit diagram

### 23.6 Wiring Diagram: Thermocouple Optional (ECP1000C)

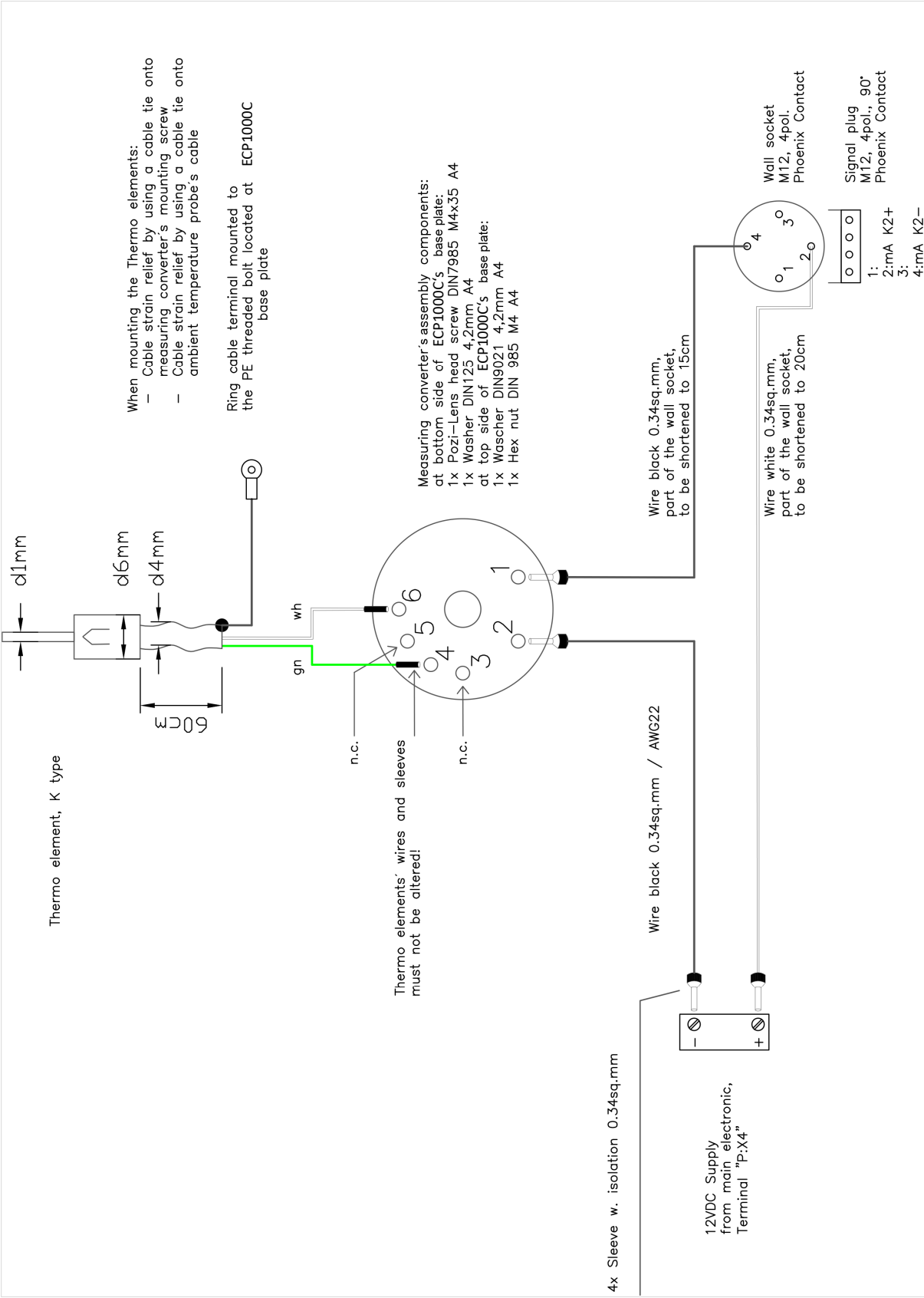





































Figure 28 Wiring diagram: Thermocouple connection (ECP1000C)

### 23.7 Table of Parameter Codes

No.	Description:	Default:	Range:	Note:	Will be canceled after factory reset
1	Software version				
5	Brightness setting of display	5	0 - 9	Brightest display setting is 9	x
10	LA on/off switching Channel 1	0	0,1,2	0=off; 1= without cable break detection; 2= with cable break detection	x
11	Sensitivity LA Channel 1	2	1-7	The higher the value is, the sooner the alarm is triggered.	x
12	HIGH dT Channel 1	3	2 - 8 [°C]	Differential temperature between set point and upper temperature alarm limit	x
13	LOW dT Channel 1	3	2 - 8 [°C]	Differential temperature between setpoint and lower temperature alarm limit	x
14	Hysteresis (temperature alarm) Channel 1	2	1,2 [°C]	As soon as a temperature alarm limit of "2" is selected, the hysteresis is automatically reduced to 1	x
15	mA range selection Channel 1	4-20	0-20 / 4-20 [mA]	Corresponds to the temperature range: -10 °C to +50 °C (4 – 20 mA: at 5 °C = 8 mA)	x
20	LA on-/off switching Channel 2	0	0,1,2	0=off; 1= without cable break detection; 2= with cable break detection	x
21	Sensitivity LA Channel 2	2	1-7	The higher the value is, the sooner the alarm is triggered.	x
22	HIGH dT Channel 2	3	2 - 8 [°C]	Differential temperature between setpoint and upper temperature alarm limit	x
23	LOW dT Channel 2	3	2 - 8 [°C]	Differential temperature between setpoint and lower temperature alarm limit	x
24	Hysteresis (temperature alarm) Channel 2	2	1,2 [°C]	As soon as a temperature alarm limit of "2" is selected, the hysteresis is automatically reduced to 1	x
25	mA range selection Channel 2	4-20	0-20 / 4-20 [mA]	Corresponds to the temperature range: -10 °C to +50 °C (4 – 20 mA: at 5 °C = 8 mA)	x
70	Operating time in days			This value will not be deleted even after restarting	
84	Fan speed	1	0-5	Value has no influence on the output power	
210	Calibration LA dry Channel 1			Connect the sensor and confirm with the  -key.	
211	Calibration LA wet Channel 1			Hold the sensor in water and confirm with the  -key.	
212	Calibration LA open / cable break Channel 1			Disconnect the sensor and confirm with the  -key. The cable break detection <b>triggers in the middle between this value and that of dry.</b>	
213	Display LA dry			Check here the current value	

No.	Description:	Default:	Range:	Note:	Will be canceled after factory reset
	Channel 1				
214	Display LA wet Channel 1			Check here the current value	
215	Display LA open Channel 1			Check here the current value	
220	Calibration LA dry Channel 2			Connect the sensor and confirm with the  -key.	
221	Calibration LA wet Channel 2			Hold the sensor in water and confirm with the  -key.	
222	Calibration LA open / cable break Channel 2			Disconnect the sensor and confirm with the  -key. The cable break detection <b>triggers in the middle between this value and that of "LA dry"</b> .	
223	Display LA dry Channel 2			Check here the current value	
224	Display LA wet Channel 2			Check here the current value	
225	Display LA open Channel 2			Check here the current value	
310	mA output LOW Calibration Channel 1	1 mA		Connect the multimeter and press or hold  or  -keys until the display matches <b>1mA</b> .	
311	mA output HIGH Calibration Channel 1	20 mA		Connect the multimeter and press and hold  or  -keys until the display matches <b>20 mA</b> .	
320	mA output LOW Calibration Channel 2	1 mA		Connect the multimeter and press or hold  or  -keys until the display matches <b>1 mA</b> .	
321	mA output HIGH Calibration Channel 2	20 mA		Connect the multimeter and press and hold  or  -keys until the display matches <b>20 mA</b> .	
777	Reset to factory settings			After "777" has been entered and confirmed, a "0" is blinking. Use the arrow keys to switch between "0" and "1". With "1" and confirmation, the device is reset to the factory setting.	

## 23.8 Quick Guide

<p><b>Enter PIN „1234“</b></p> 	<p>Press and hold the -key until "0000" appears in the display. The "0" on the left side is blinking. Use the  and -keys to enter the first digit of the PIN. Use the  and -keys to switch to the other digits. If a digit is blinking, enter the PIN digit. Confirm the PIN with the -key.</p>
<p><b>Set value entry</b></p>  	<p>After entering the PIN, briefly tap the -key or keep the key pressed for 2 seconds in the main menu (temperature or set point display) while the PIN is active. The set point entry appears. The two digits are blinking. The set point can be set between 2 and 15 °C using the  and -keys. Use the  and -keys to switch between the operating mode and setpoint settings. When the letter on the left side is blinking, use the  and -keys to switch between absolute and differential value control of the set point temperature.</p>
<p><b>Parameter settings</b></p> 	<p>After entering the PIN, press and hold the -key. First the setpoint of the cooler temperature appears, then the display changes to code entry. The left digit starts blinking. A code can have up to 3 digits. Use the  and -keys to enter the first digit of the code. Use the  and -keys to switch to the other digits. After entering all digits, press the -key to confirm, and press  to discard the entry. The display shows the cooler temperature again after changing or aborting.</p>

No.	Description	Default	Range	Note	C777*
1	Software version				
5	Brightness setting of display	5	0 - 9	Brightest display setting is 9	x
10	LA on/off Channel 1	0	0,1,2	0=off; 1=w/o cable break; 2=with cable break	x
11	Sensitivity LA Channel 1	2	1 - 7	The higher the value is, the sooner the alarm is triggered.	x
12	HIGH dT Channel 1	3	2 - 8 [°C]	Differential temperature between setpoint and upper temperature alarm limit	x
13	LOW dT Channel 1	3	2 - 8 [°C]	Differential temperature between setpoint and lower temperature alarm limit	x
14	Hysteresis (temperature alarm) Channel 1	2	1,2 [°C]	As soon as a temperature alarm limit of "2" is selected, the hysteresis is automatically reduced to 1.	x
15	mA range selection Channel 1	4-20	0-20 / 4-20 [mA]	Corresponds to the temperature range: -10 to +50 °C (4 – 20 mA: at 5 °C = 8 mA)	x
20	LA on/off Channel 2	0	0,1,2	0=off; 1=w/o cable break; 2=with cable break	x
21	LA Sensitivity Channel 2	2	1 - 7	The higher the value is, the sooner the alarm is triggered.	x
22	HIGH dT Channel 2	3	2 - 8 [°C]	Differential temperature between setpoint and upper temperature alarm limit	x
23	LOW dT Channel 2	3	2 - 8 [°C]	Differential temperature between setpoint and lower temperature alarm limit	x
24	Hysteresis (temperature alarm) Channel 2	2	1,2 [°C]	As soon as a temperature alarm limit of "2" is selected, the hysteresis is automatically reduced to 1.	x
25	mA range selection Channel 2	4-20	0-20 / 4-20 [mA]	Corresponds to the temperature range: -10 to +50 °C (4 – 20 mA: at 5 °C = 8 mA)	x
70	Operating time in days			Value will not be deleted, even after restarting	
84	Fan speed	1	0-5	Value has no influence on the output power	
777	Reset to factory settings*			After "777" has been entered and confirmed, a "0" is blinking. Use arrow keys to switch between "0" and "1". Enter "1" and confirm, device is reset to the factory setting.	

\*Codes with „x“ in „C777“ column: values will be reset to factory default values if code „777“ is confirmed.